

T1 EAVE GUTTER DETAIL

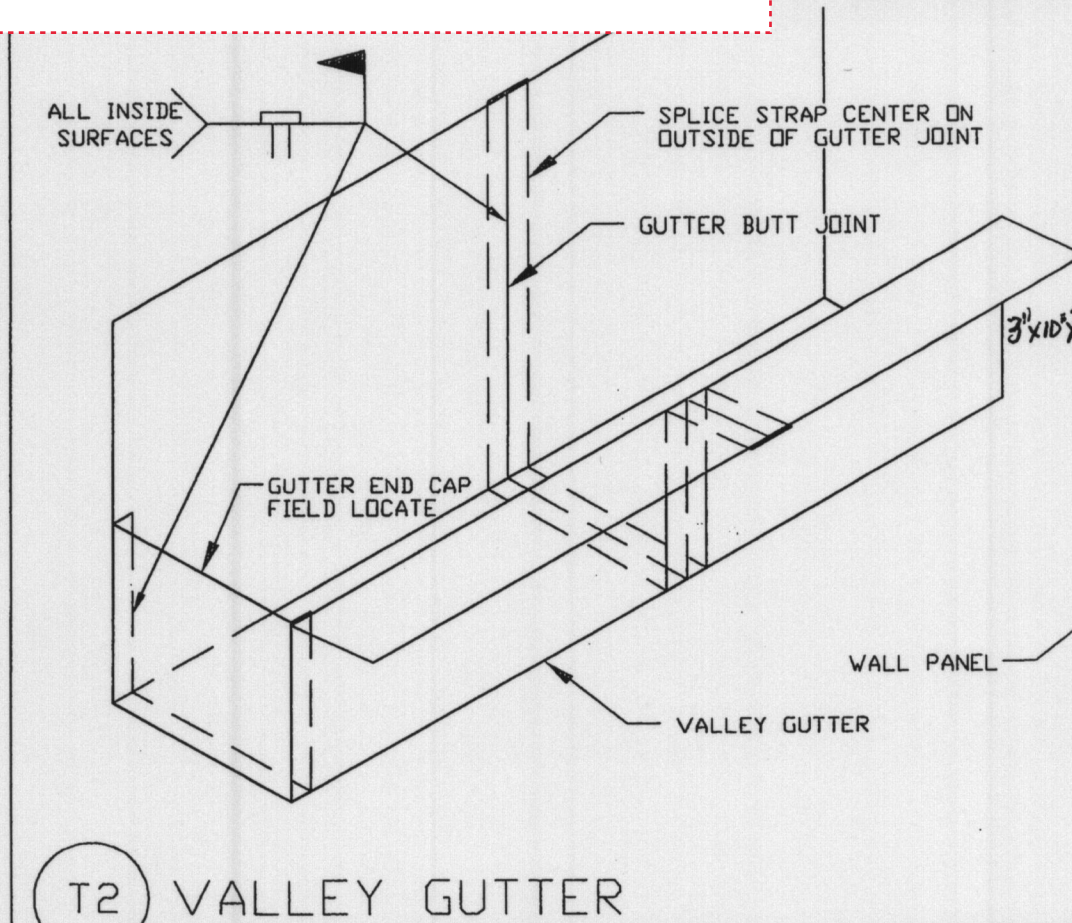

T2 VALLEY GUTTER

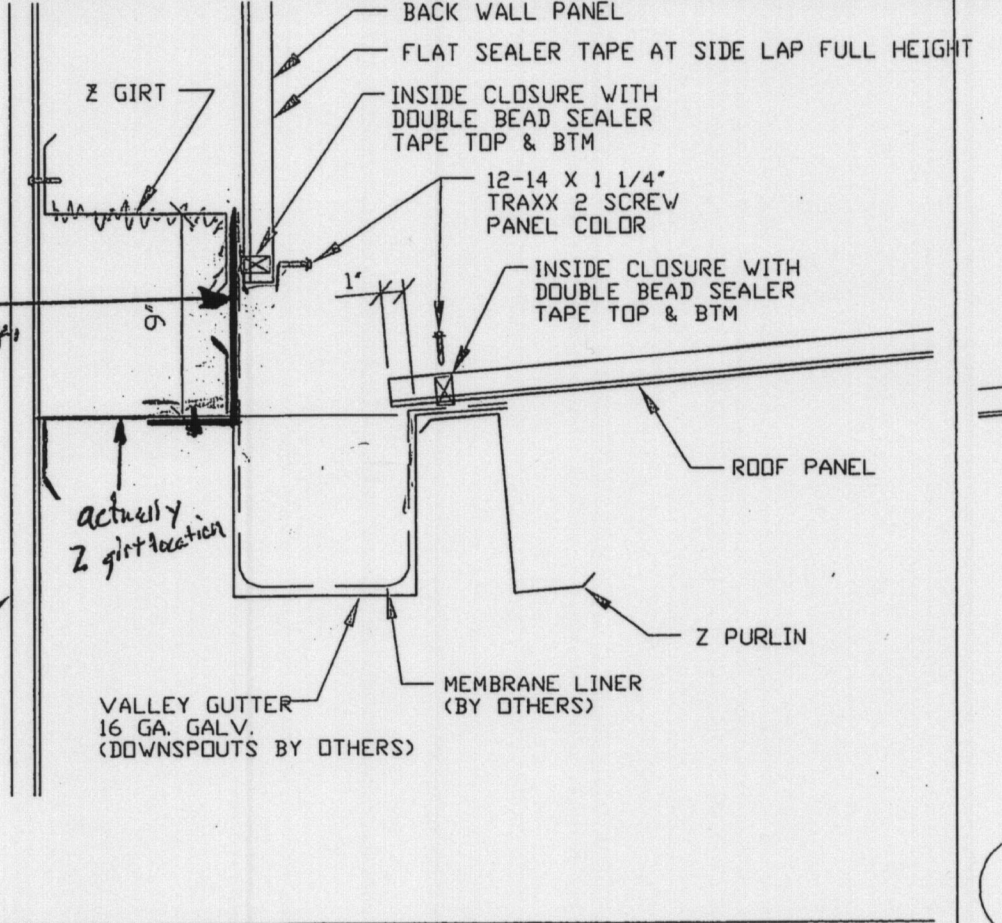

T3 RIDGE CAP DETAIL

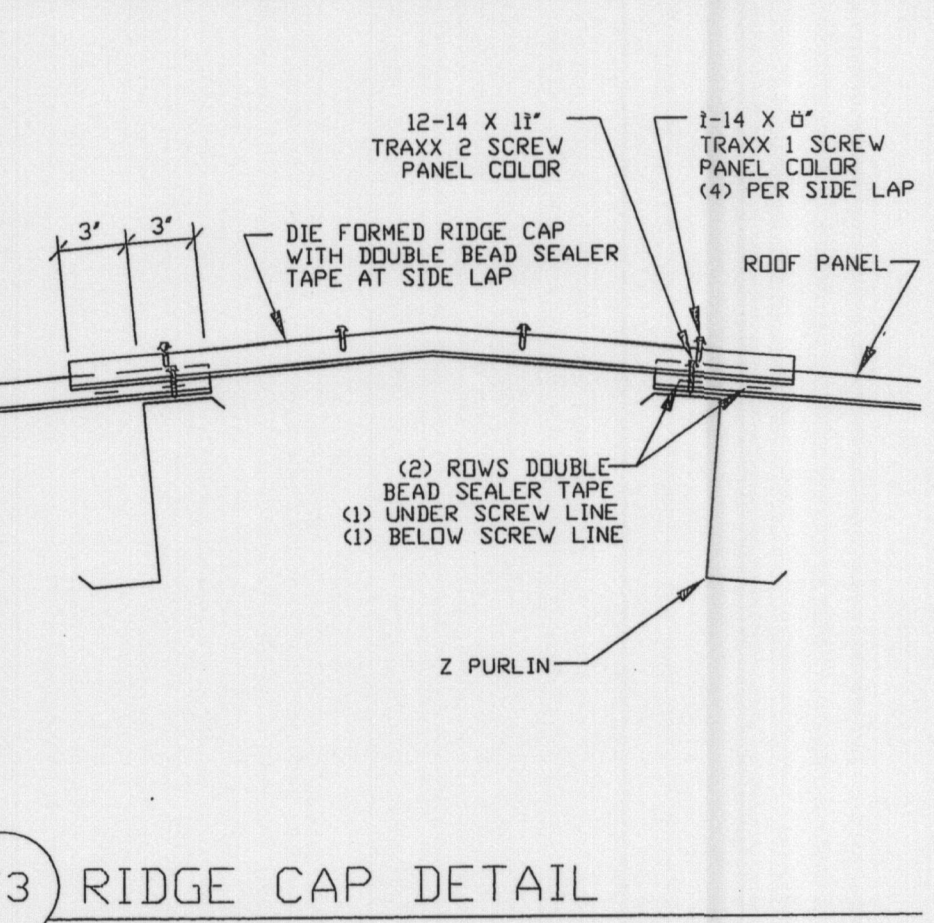

T4 WALL TO LOW ROOF

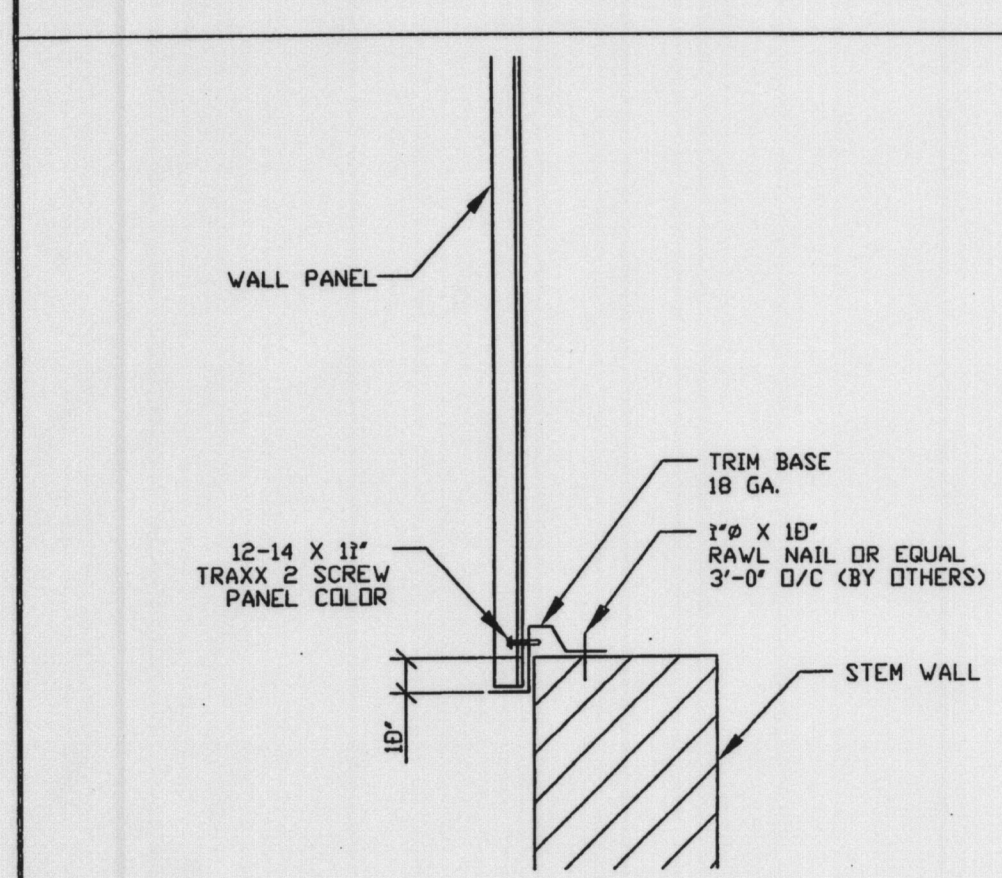

T5 PANEL BASE DETAIL

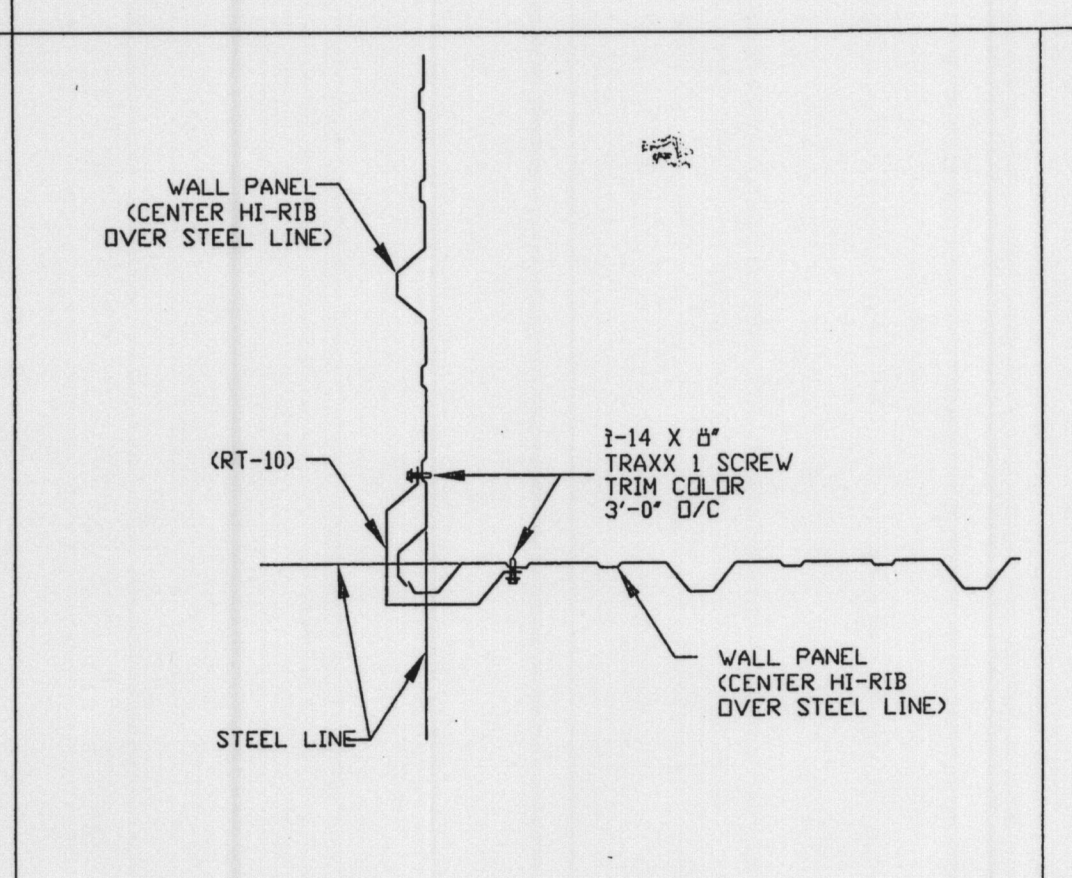

T6 OUTSIDE CORNER DETAIL

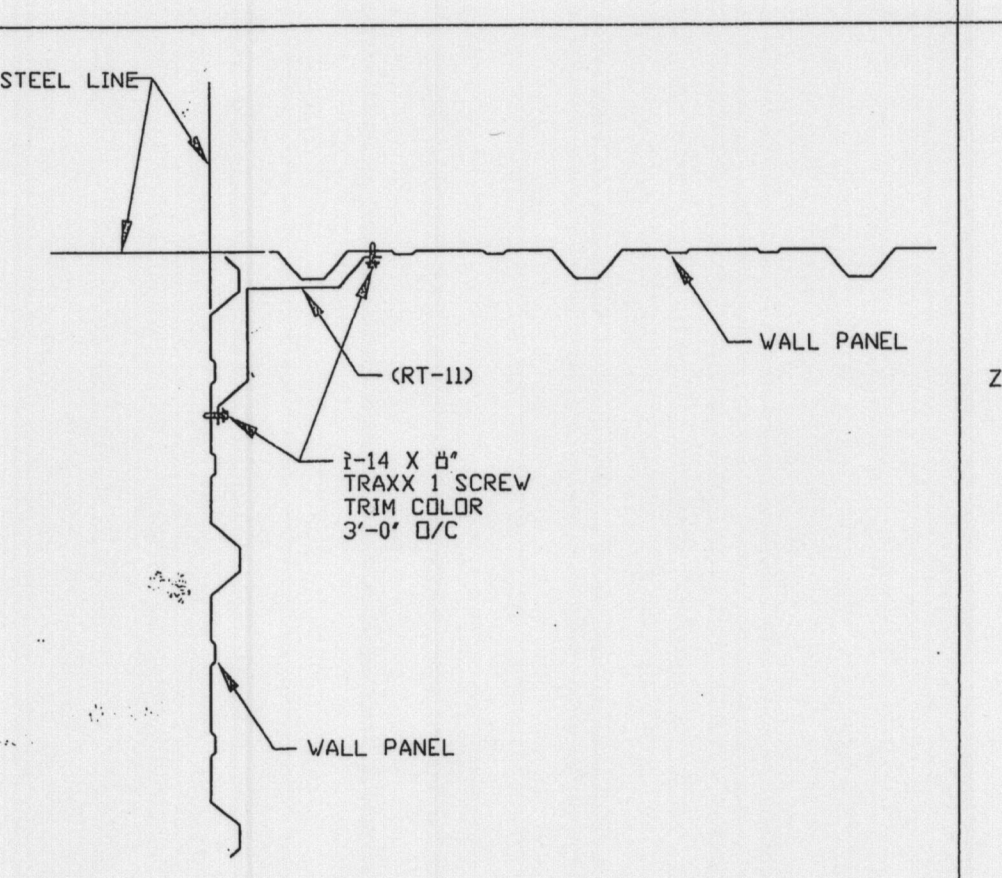

T7 INSIDE CORNER DETAIL

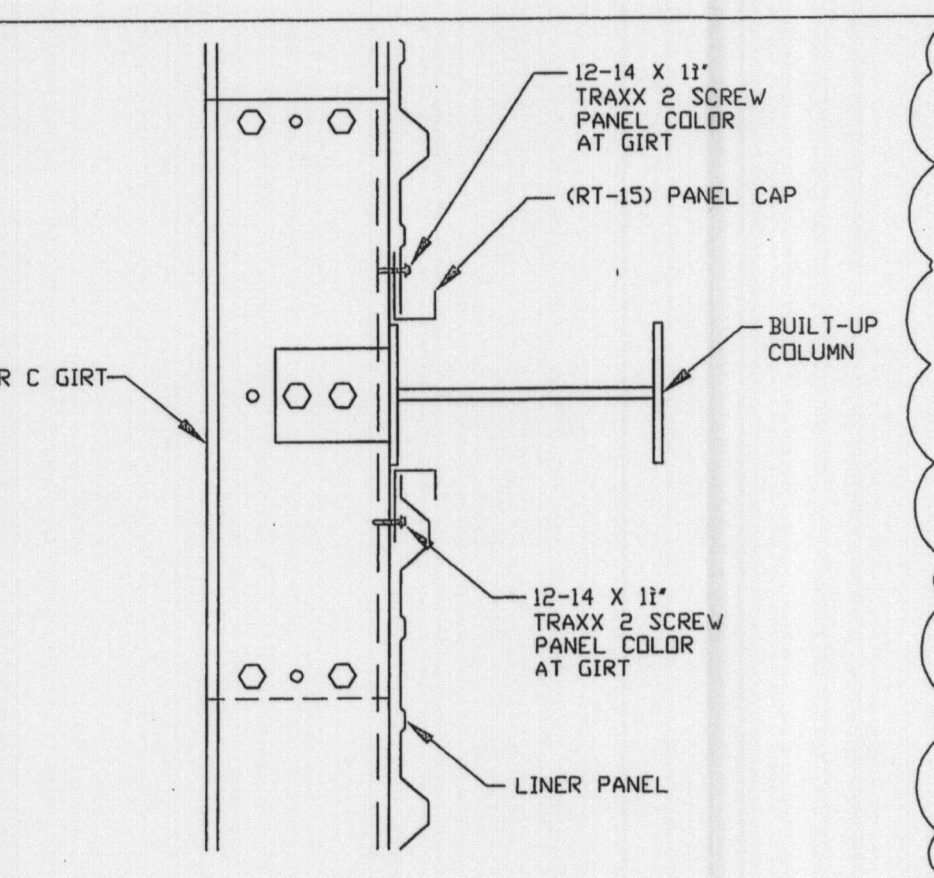

T8 LINER PANEL AT COLUMN



T9 NOT USED

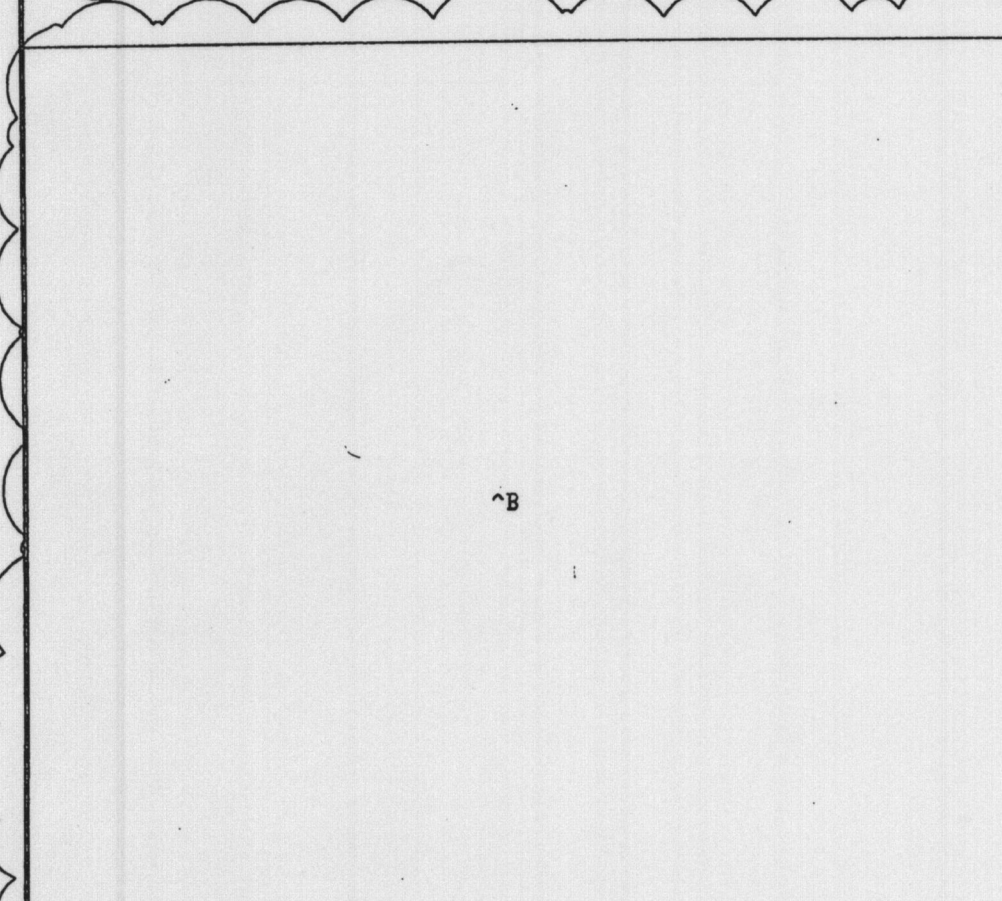

T10 NOT USED

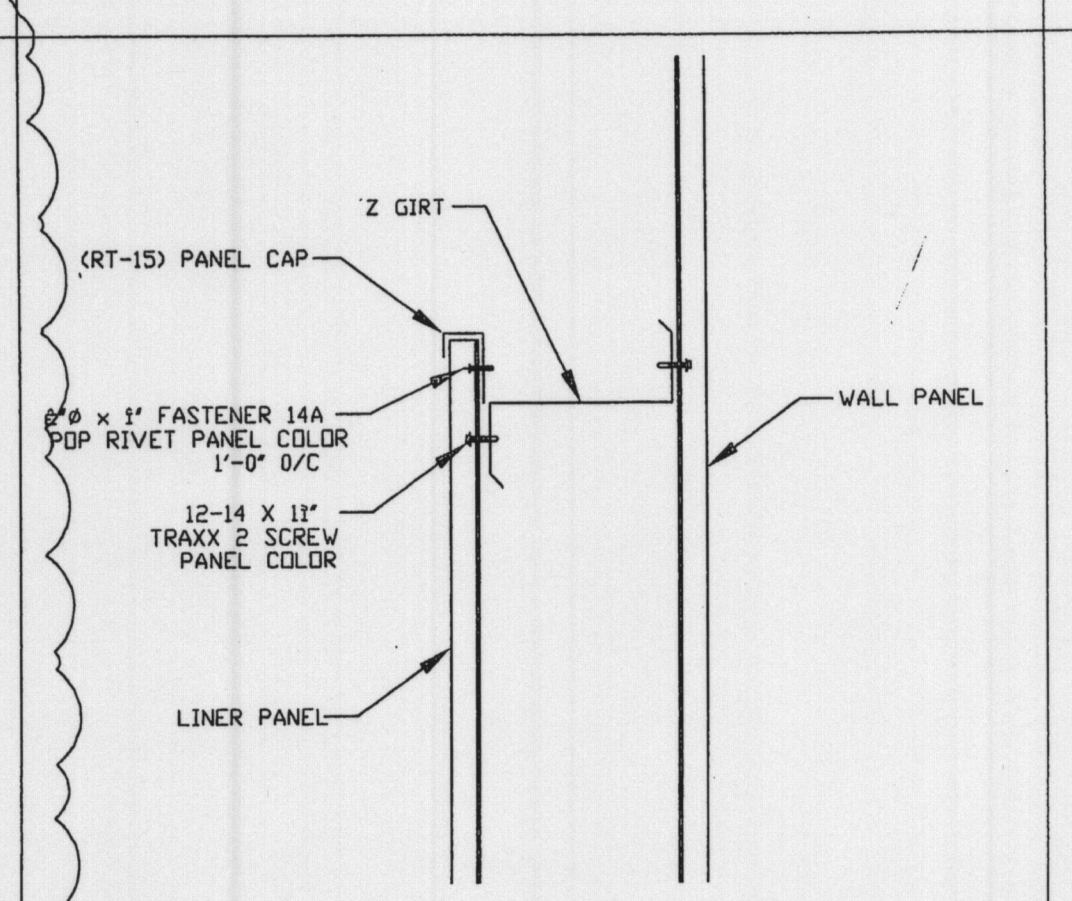

T11 LINER PANEL AT GIRT

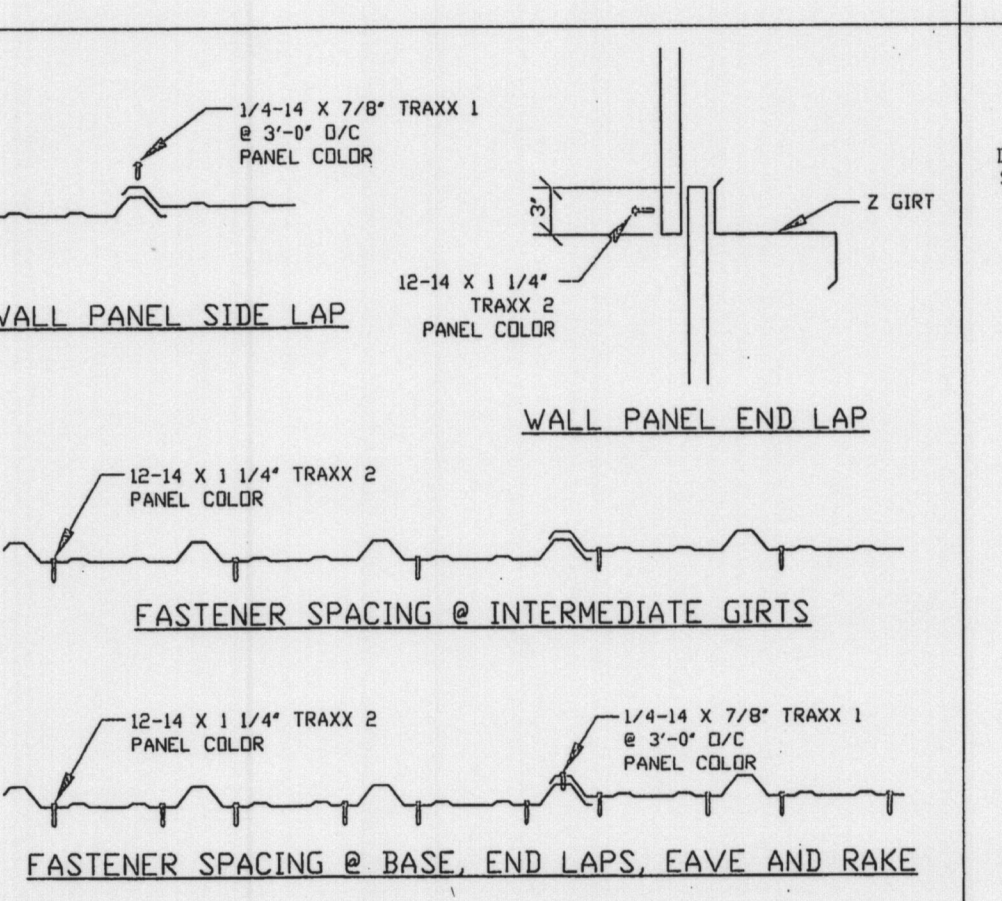

T12 WALL SCREWS

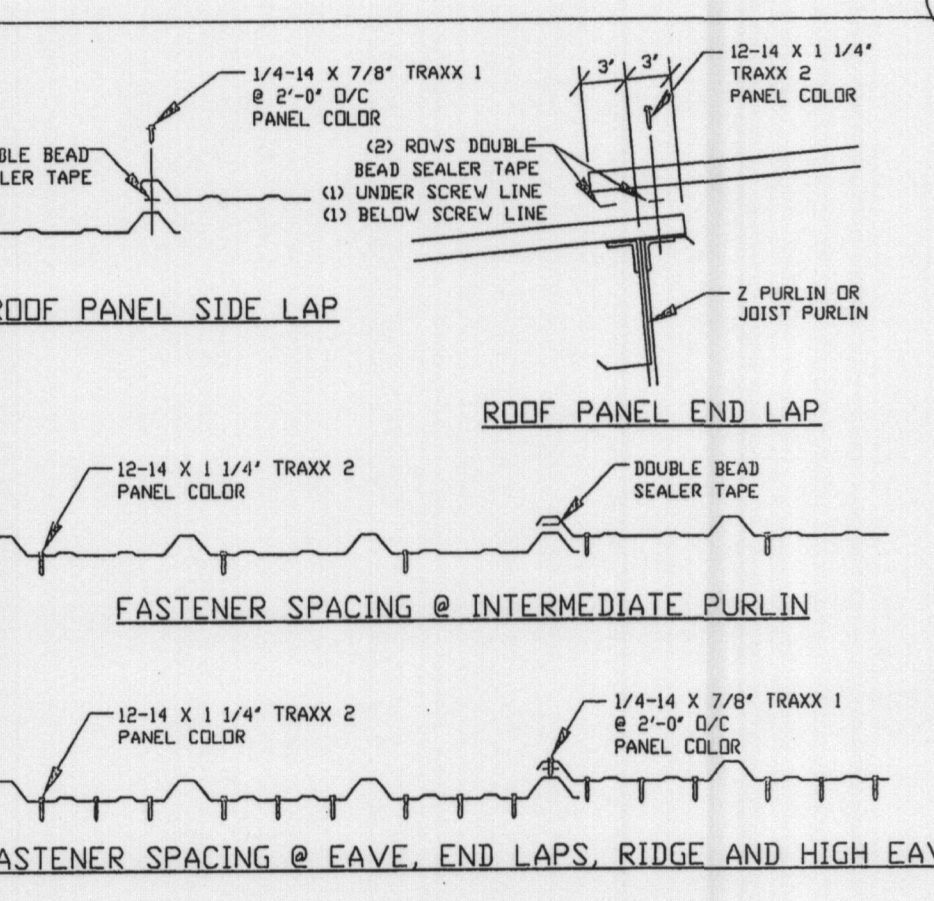

T13 ROOF SCREWS

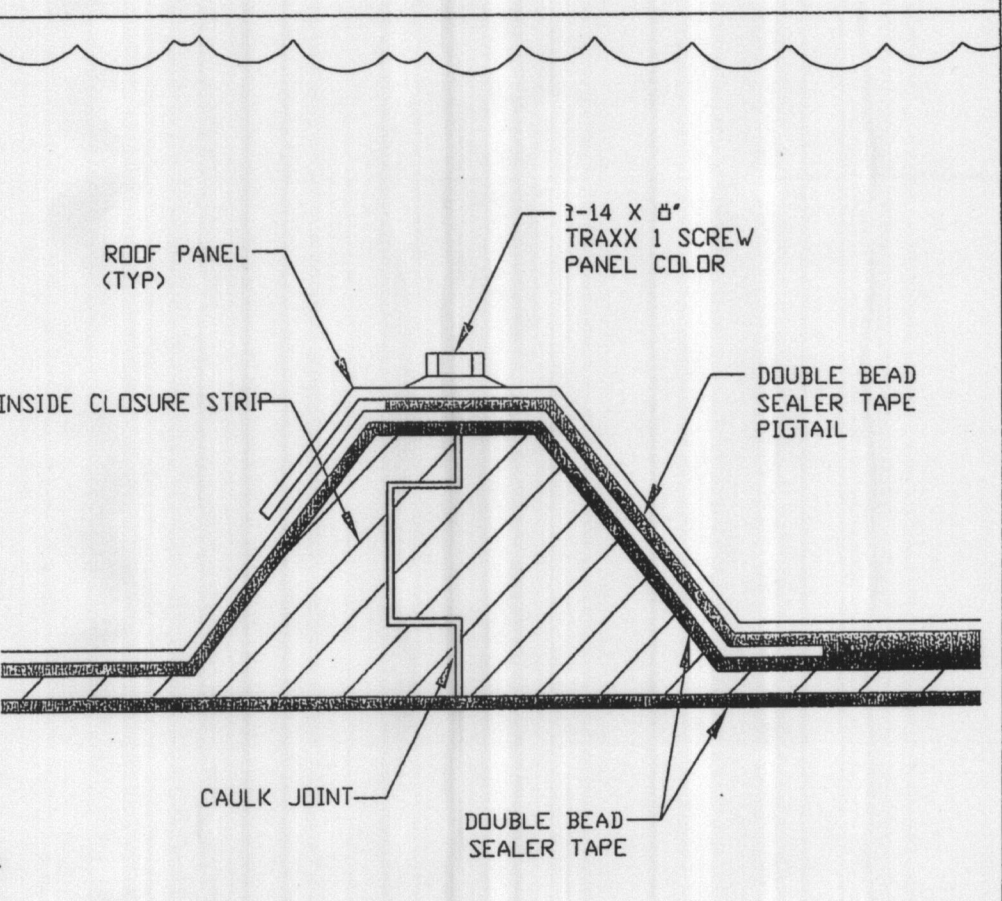

T14 SEALER TAPE/CLOSURE AT EAVE

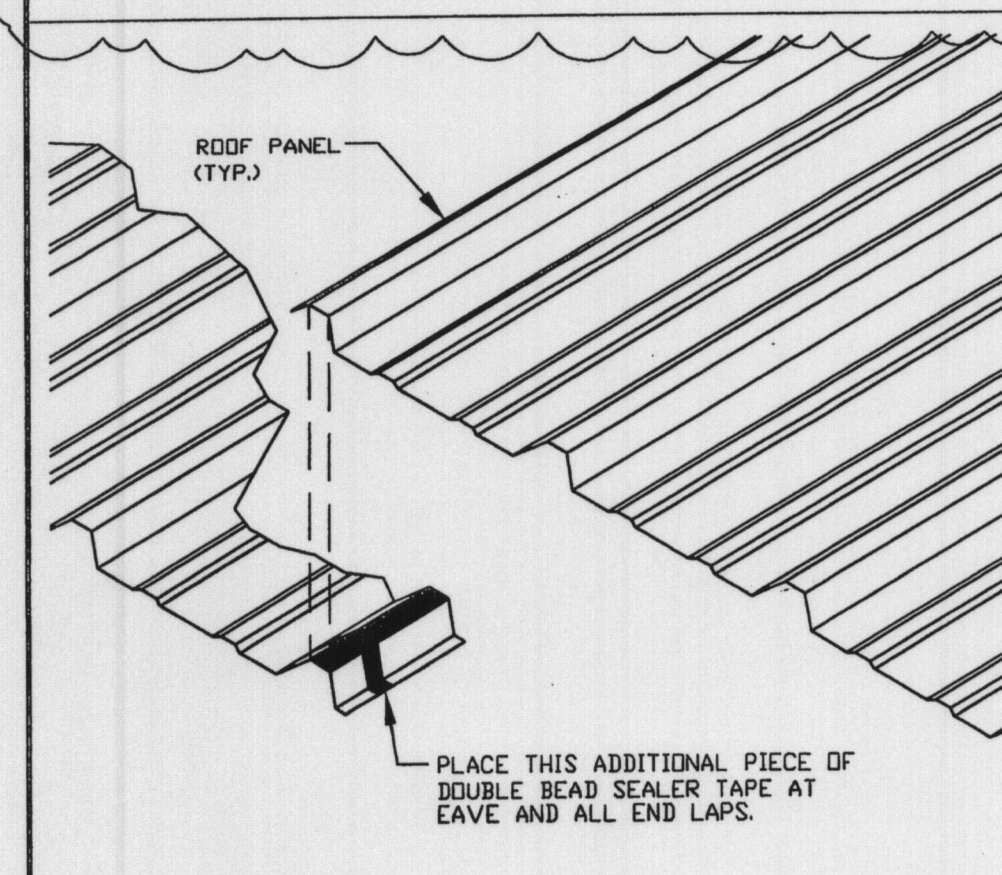

T15 SEALER TAPE AT EAVE SIDE

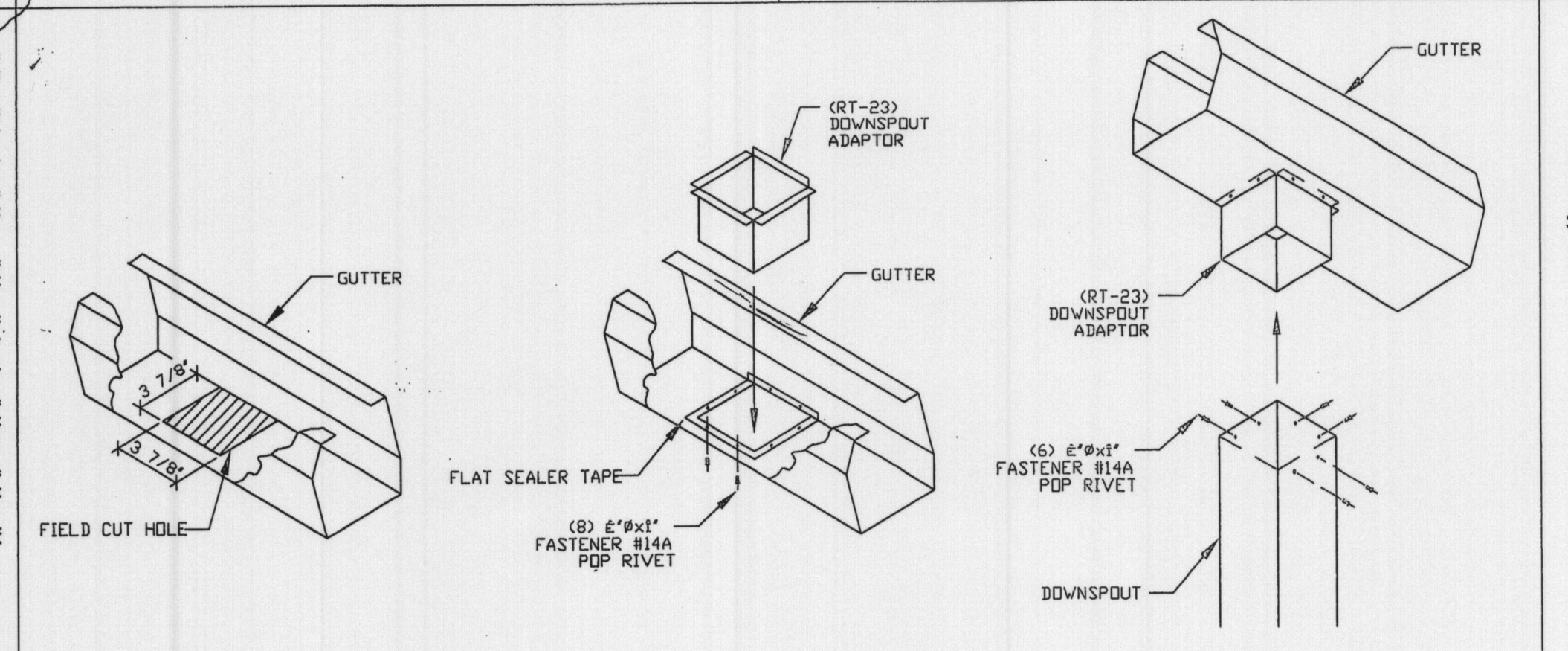

T16 DOWNSPOUT TO GUTTER

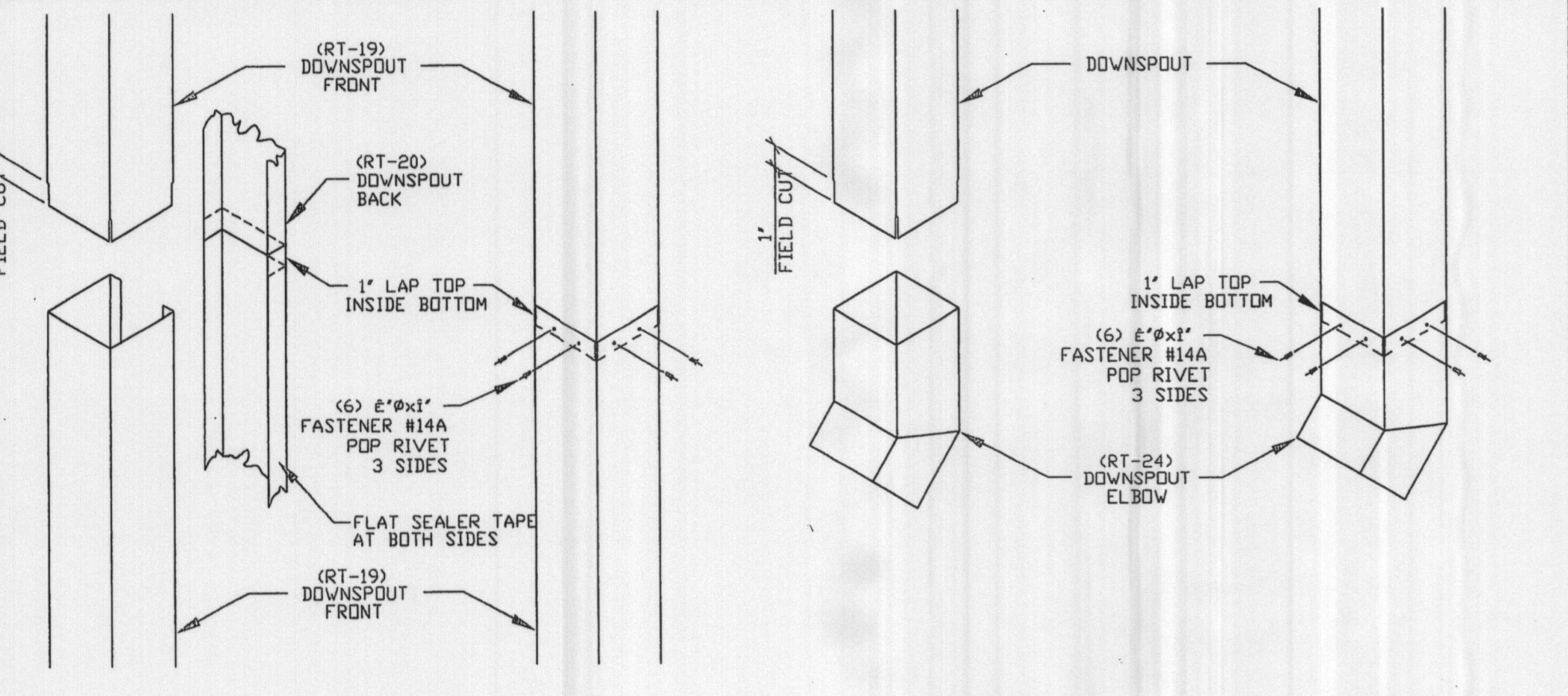

T17 2 PIECE DOWNSPOUT SPLICE & ELBOW

This drawing, the design it depicts, and the information contained herein are the exclusive property of GEM Buildings and may not be copied, reproduced, used for fabrication, purchasing of materials, or any other purpose without the written permission of GEM Buildings. Copyright GEM Buildings 2004.

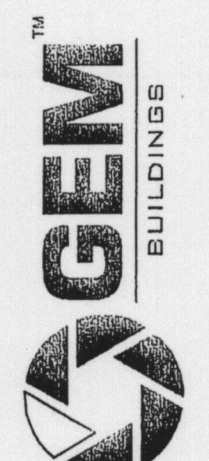
NO.	REVISIONS	DATE	PROFESSIONAL SEAL
	A	DESIGN DRAWING - ISSUED FOR CONSTRUCTION	4/20/05
B	DESIGN DRAWING - REISSUED FOR CONSTRUCTION	4/21/05	
			
HAFB FIGHTER GALLERY ADDITION ROY, UTAH BIG D CONSTRUCTION TRIM DETAILS			
1025 N. WATERY LANE BRIGHAM CITY, UT 84302 (435) 723-5000		CHECKED ENGINEER DATE TKL 4/13/05	SCALE N.T.S.
SHEET		D3.1	
JOB NUMBER		03087	

