

FAA-STD-019f  
October 18, 2017



DEPARTMENT OF TRANSPORTATION  
FEDERAL AVIATION ADMINISTRATION  
STANDARD

**LIGHTNING AND SURGE PROTECTION,  
GROUNDING, BONDING, AND SHIELDING  
REQUIREMENTS FOR  
FACILITIES AND ELECTRONIC EQUIPMENT**

## FOREWORD

1. Construction of Federal Aviation Administration (FAA) operational facilities and the electronic equipment installed therein shall conform to this standard. This standard defines minimum requirements for FAA facilities. When specific needs of a facility exceed these minimum requirements, the facility design and construction shall meet the specific needs. The equipment type, configuration, and location along with the configuration of site structures and environmental/weather conditions influence these needs.
2. The requirements herein reflect lessons learned from investigation and resolution of malfunctions and failures experienced at field locations. The FAA thus considers these requirements the minimum necessary to harden sites sufficiently for the FAA missions – to prevent delay or loss of service, to minimize or preclude outages, and to enhance personnel safety. Further, the requirements herein are coordinated with industry standards, and in some cases exceed industry standards where necessary to meet the FAA missions.
3. The use of “shall” or verbs such as “provide,” “construct,” “weld,” or “connect” indicates mandatory compliance. Deviations are permissible in cases when implementation of certain requirements is not technically feasible, and in such cases, the FAA shall submit a National Airspace System (NAS) Change Proposal (NCP) with justification and technical documentation, and receive approval by the NAS Configuration Control Board (CCB).
4. The format and content requirements of this standard are in accordance with FAA-STD-068, and the grammar and style are in accordance with the Government Printing Office (GPO) Style Manual.

This Page Intentionally Left Blank

TABLE OF CONTENTS

**1 SCOPE .....1**

1.1 Applications.....1

1.2 Tailoring of Mandatory Requirements .....1

1.3 Purpose .....1

1.4 Content Organization .....2

**2 APPLICABLE DOCUMENTS.....5**

2.1 General.....5

2.2 Government Documents.....5

    2.2.1 FAA Specifications.....5

    2.2.2 FAA Orders and Handbooks .....5

    2.2.3 Military Documents .....5

2.3 Non-Government Documents.....6

    2.3.1 Electronic Industries Alliance (EIA) .....6

    2.3.2 National Fire Protection Association (NFPA).....6

    2.3.3 Underwriters Laboratories (UL) .....7

    2.3.4 Institute of Electrical and Electronic Engineers (IEEE).....7

    2.3.5 Electrostatic Discharge (ESD) Association Documents .....7

    2.3.6 Telecommunication Industry Association (TIA) Documents .....7

**3 DEFINITIONS .....9**

**4 GENERAL REQUIREMENTS.....15**

4.1 Introduction.....15

4.2 Bonding Requirements .....15

    4.2.1 General.....15

    4.2.2 Dissimilar Metals.....15

    4.2.3 Methods of Bonding.....17

    4.2.4 Bonding Connections – Installation Requirements.....21

    4.2.5 Bonding Connections – Hardware for Bonding Jumpers and Straps .....22

4.3 Lightning Protection System Requirements.....24

    4.3.1 General.....24

    4.3.2 Lightning Protection System – Components.....24

    4.3.3 Lightning Protection System – Material Class Requirements .....24

    4.3.4 Lightning Protection for NAS Facilities Buildings and Structures .....24

    4.3.5 Lightning Protection System - Conductor Routing.....25

    4.3.6 Lightning Protection System - Air Terminals .....28

    4.3.7 Lightning Protection System - Hardware .....29

    4.3.8 Lightning Protection System – Bonding Connections.....30

4.4 Earth Electrode System (EES).....32

    4.4.1 General.....32

    4.4.2 [A3] Site Survey and Geotechnical Investigation .....32

    4.4.3 EES – Design .....32

    4.4.4 EES - Configuration.....32

    4.4.5 Grounding Enhancement Materials for Earth Electrode System (EES) Installation .....35

    4.4.6 Installation of Earth Electrode Systems in Corrosive Soils.....36

4.5 National Electric Code - Power Distribution System Grounding Compliance.....38

    4.5.1 General.....38

    4.5.2 Grounding Electrode Conductors (GEC) .....38

    4.5.3 Equipment Grounding Conductors (EGC).....38

4.5.4 Grounding Bushings for Conduit Raceways .....38

4.5.5 Interior Metal Piping Systems .....41

4.5.6 Building Structural Steel .....41

4.6 Surge Protection Device (SPD) Requirements.....42

4.6.1 General.....42

4.6.2 SPD for Power Distribution System .....42

4.6.3 SPD for Signal, Control, and Data Line Surge Protection .....45

4.7 Grounding and Bonding for NAS Electronic Equipment Areas .....46

4.7.1 General.....46

4.7.2 Main and Supplemental Ground Plates .....46

4.7.3 Signal Reference Structures (SRS) – Requirements .....48

4.7.4 Bonding of Electrical Systems in NAS Electronic Equipment Areas .....56

4.8 Shielding Requirements.....57

4.8.1 General.....57

4.8.2 Facility Shielding.....57

4.8.3 Shielding for Conductors and Cabling.....57

4.8.4 Electromagnetic Environment Control .....61

4.9 Electrostatic Discharge (ESD) Requirements.....62

4.9.1 General.....62

4.9.2 Requirements.....62

**5 DETAILED REQUIREMENTS.....64**

5.1 Introduction.....64

5.2 Airport Traffic Control Tower (ATCT) Facilities .....65

5.2.1 General.....65

5.2.2 Lightning Protection System .....66

5.2.3 Main Ground Connections .....67

5.2.4 Power Distribution System.....71

5.2.5 NAS Electronic Equipment Areas .....71

5.3 Lightning Protection System – Special Conditions .....73

5.3.1 General.....73

5.3.2 Antenna Towers .....73

5.3.3 Antenna Protection .....76

5.3.4 Tower Guying.....76

5.3.5 Waveguide, Axial Cable, and Conduit Grounding .....76

5.3.6 Staircase and Ladder Protection .....76

5.3.7 Lightning Protection for Facilities without Buildings or Antennas.....77

5.3.8 Lightning Protection for Fences and Gates .....77

5.3.9 Lightning Protection for Photovoltaic Solar Arrays.....78

5.4 Facility Transient Protection – Special Conditions.....80

5.4.1 General.....80

5.4.2 Existing Metallic Conduit, Conductors, and Cables .....80

5.4.3 Electromagnetic Shielding for Lines, Conductors, and Cables.....80

5.4.4 Balanced Pair Cables .....84

5.4.5 Fiber Optic Cable.....84

5.4.6 Interior Wiring, Conductors, and Cables .....85

5.5 Single Point Ground System (SPG) – Special Conditions .....86

5.5.1 General.....86

5.5.2 Isolation between SPG and Other SRS Systems.....86

5.5.3 Resistance of Bonds.....86

5.5.4 SPG - Ground Plates.....86

5.5.5 SPG - Ground Conductors .....86

5.5.6 Labeling .....87

**5.5.7 Protection..... 87**

**5.6 NAS Electronic Equipment – Interface and Procurement Requirements ..... 89**

5.6.1 General..... 89

5.6.2 Electronic Signal Lines and Cables - Shielding ..... 89

5.6.3 Signal, Control, and Data Line Entrance – Transient Protection..... 89

5.6.4 Equipment Power Entrance – Transient Protection ..... 90

5.6.5 NAS Electronic Equipment Enclosures and Assemblies - Grounding and Bonding..... 93

5.6.6 NAS Electronic Equipment – Equipment Grounding and Bonding..... 96

5.6.7 Equipment Shielding Requirements..... 98

5.6.8 NAS Electronic Equipment - Electrostatic Discharge Protection..... 99

5.6.9 Secure Facilities..... 100

5.6.10 High RF Field Bonding Requirements..... 100

**5.7 Surge Protective Device (SPD) – Equipment Specification Requirements ..... 100**

5.7.1 General..... 100

5.7.2 Surge Protective Device (SPD) for Power Distribution Equipment Protection..... 100

5.7.3 SPDs for NAS Electronic Equipment – Design and Procurement Requirements ..... 104

5.7.4 SPD - Design Specification for Axial Cable Protection..... 104

**5.8 Electrostatic Discharge (ESD) Protection – Interface and Specification Requirements..... 105**

5.8.1 General..... 105

5.8.2 Electrostatic Discharge (ESD) Sensitivity Classification ..... 105

5.8.3 Classification of Materials..... 105

5.8.4 Hard and Soft Grounds ..... 106

5.8.5 Protection of Electrostatic Discharge (ESD) Susceptible and Sensitive Items..... 107

5.8.6 ESD Controls Required for ESD Special Protection Areas..... 107

5.8.7 ESD Signs, Labels, Cautions, and Warnings for ESD Protection Areas..... 109

5.8.8 Electrostatic Discharge (ESD) Protective Storage Areas..... 109

5.8.9 Electrostatic Discharge (ESD) Control Flooring and Floor Coverings ..... 110

5.8.10 Electrostatic Discharge (ESD) Requirements for Raised Access Floor Systems ..... 110

5.8.11 Electrostatic Discharge (ESD) Protective Worksurfaces..... 111

5.8.12 Static Dissipative Coatings ..... 112

5.8.13 Electrostatic Discharge (ESD) Protected Workstations ..... 112

**5.9 Electromagnetic Compatibility Requirements ..... 113**

5.9.1 General..... 113

5.9.2 [A6] Requirements ..... 113

5.9.3 Approval ..... 113

**6 NOTES..... 115**

6.1 Acronyms and Abbreviations ..... 115

6.2 Guidelines and Reference Notes ..... 118

6.3 Version Cross-Reference ..... 118

6.4 Bibliography ..... 119

**List of Figures**

Figure 1. Order of Assembly for Bolted Connections .....21

Figure 2. Lightning Protection System Main Conductor Connections – Illustrative Example ....27

Figure 3. Main and Down Conductor Termination to EES – Illustrative Example.....28

Figure 4. Typical Service Rack EES Installation – For Illustrative Purposes Only .....33

Figure 5. Grounding Trench Detail.....37

Figure 6. Ground Dissipation Plate Detail.....37

Figure 7. Bonding of Grounding Conductor to Conduit or Equipment.....40

Figure 8. SPD Location Diagram - Close Proximity Allowance Decision Tree .....44

Figure 9. Typical Facility Grounding System.....47

Figure 10. Multipoint Ground Conductor Size Determination .....50

Figure 11. Electronic Equipment Grounding.....54

Figure 12. Grounding of Overall Cable Shields to Connectors and Penetrating Walls.....60

Figure 13. Grounding of Overall Cable Shield to Terminal Strip .....61

Figure 14. Airport Traffic Control Tower – Typical Floor Levels.....65

Figure 15. Typical Electronic Equipment Grounding Riser Diagram for ATCT (Preferred Method).....69

Figure 16. Typical Electronic Equipment Grounding Riser Diagram for ATCT (Alternative Method).....70

Figure 17. Lightning Protection for Radomes and Radar Antenna Platforms .....75

Figure 18. Fence Grounding .....79

Figure 19. Buried Guard Wire Detail for Underground Cables or Cable Ductbanks.....84

Figure 20. Single-Point Ground System Installation – Illustrative Example.....88

Figure 21. Lines and Cables Requiring Protection .....90

Figure 22. Bonding of Connectors to Mounting Surface.....95

Figure 23. Single Point Ground Bus Bar Installation in Rack or Cabinet .....98

***Note.** Colors in figure illustrations distinguish the fundamental elements of the grounding system concept and do not represent color-coding or labeling requirements of this standard.*

**List of Tables**

Table 1. Mechanical Bonds Between Dissimilar Metals .....16

Table 2. Connection Torque Requirements for Bolted Bonds.....20

Table 3. Size of Electronic Multipoint Ground Interconnecting Conductors.....51

Table 4. Ground Plate Specification Requirements.....52

Table 5. Grounding Conductor Insulation Color Codes .....55

Table 6. Minimum Separation Distance between Signal and Power Conductors .....62

Table 7. ATCT MPG Configuration – Parallel Conductor Complements.....68

Table 8. Electronic Equipment Power Entrance SPD - Slope Resistance ( $R_{slope}$ ) .....92

Table 9. Electronic Equipment Power Entrance SPD - Voltage Protection Rating ( $V_3$ ).....92

Table 10. Electronic Equipment Power Entrance SPD – Surge Current Lifetime Rating.....92

Table 11. Power Distribution Equipment SPD – Surge Current Lifetime Rating .....102

Table 12. Power Distribution Equipment SPD - Slope Resistance ( $R_{slope}$ ) .....103

Table 13. Power Distribution SPD Voltage ( $V_3$ ) Protection Rating.....103

This Page Intentionally Left Blank



## 1 SCOPE

This standard establishes design, procurement, installation, construction, and evaluation standards for lightning protection, transient surge protection, grounding, bonding, shielding configurations and procedures, and control of electrostatic discharge (ESD).

### 1.1 Applications

The requirements of this standard are mandatory for both new facilities and modifications and upgrades to existing facilities, new equipment installations, and new electronic equipment procurement used in the National Airspace System (NAS) facilities.

The use of the term “facilities” herein can differ from the manner in which it is frequently used in other Federal Aviation Administration (FAA) documents. In this standard, facilities may refer to an entire building, tower, interior or exterior system(s), or portions thereof which support the NAS and its operation. The physical proximity of the system(s) or equipment typically defines a single facility, while significant physical separation of the system or equipment defines separate facilities.

This standard covers government owned or leased property and “facilities.”

- a. Contractor-Owned Equipment Interface. The interface between contractor-owned equipment or electronic equipment not used for operational purposes, such as administrative local area network (LAN), administrative telephone, and the operational NAS facilities shall be in accordance with this standard.

### 1.2 Tailoring of Mandatory Requirements

The FAA recommends that the Office of Primary Responsibility (OPR) is contacted to obtain technical guidance on the applicability of requirements herein for modifications, upgrades, and new equipment installations in existing facilities.

- a. Application for Previously Funded Programs. This standard is not mandatory for programs funded prior to the issue date of this standard, nor is it mandatory for construction contracts associated with programs funded prior to the issue of the standard. Application of this standard is at the discretion of the user for programs funded prior to the issue of the standard.
- b. Mandatory Applications. The OPR can mandate the use of this standard for programs started before the issue date of this standard, if funding is provided.



### 1.3 Purpose

The requirements of this standard provide a systematic approach to minimize electrical hazards to personnel, and minimize electromagnetic interference (EMI) that can cause damage to facilities and electronic equipment from lightning, transients, ESD, and power faults.

**1.4 Content Organization**

The standard is organized in accordance with FAA-STD-068.

<b>FAA-STD-019F Content Arrangement</b>		
<b>FOREWORD</b>		Normative Process Information
<b>1 SCOPE</b>		<p>This chapter contains:</p> <ul style="list-style-type: none"> <li>a. Scope Statement</li> <li>b. Applicability Statement for mandatory compliance with requirements</li> <li>c. Procedure for Tailoring of Mandatory Requirements</li> </ul>
<b>2 APPLICABLE DOCUMENTS</b>		This chapter includes technical documents used in this standard.
<b>3 DEFINITIONS</b>		This chapter contains definitions essential to the understanding and application of this standard. It is not intended to include commonly defined general or technical terms from building codes or industry standards.
<b>4 GENERAL REQUIREMENTS</b>		<p>This chapter addresses the general grounding system requirements commonly included in building codes and industry standards, and covers the general common requirements and standard practice for the overall design, installation, construction, and evaluation for FAA installations.</p> <p>The general requirements of industry codes and standards are often too general for many FAA applications. This chapter is organized to define and build upon the requirements of general industry standards and building codes as they relate to FAA applications.</p> <p>This chapter includes the following parts:</p> <ul style="list-style-type: none"> <li>a. Bonding Requirements</li> <li>b. Lightning Protection System Requirements</li> <li>c. Earth Electrode System Requirements</li> <li>d. National Electrical Code Power Distribution System Grounding Compliance</li> <li>e. Surge Protective Device Requirements</li> <li>f. Grounding and Bonding Requirements for NAS Electronic Equipment Areas</li> <li>g. Shielding Requirements</li> <li>h. Electrostatic Discharge Requirements</li> </ul>

<b>FAA-STD-019F Content Arrangement (continued)</b>		
<p><b>5 DETAILED REQUIREMENTS</b></p>		<p>This chapter describes detailed performance requirements, which are specific to FAA facility applications, organized by facility special conditions and equipment as follows:</p> <ul style="list-style-type: none"> <li>a. Airport Traffic Control Tower Facilities</li> <li>b. Lightning Protection System – Special Conditions</li> <li>c. Facility Transient Protection – Special Conditions</li> <li>d. Single Point Ground System (SPG) – Special Conditions</li> <li>e. NAS Electronic Equipment – Interface and Procurement Requirements</li> <li>f. Surge Protective Device (SPD) – Procurement Requirements</li> <li>g. Electrostatic Discharge Equipment – Interface and Specification Requirements</li> <li>h. Electromagnetic Compatibility Requirements</li> </ul>
<p><b>6 NOTES</b></p>		<p>This chapter includes:</p> <ul style="list-style-type: none"> <li>a. Acronyms and Abbreviations</li> <li>b. Guidelines and References Notes</li> <li>c. Version Cross-Reference</li> <li>d. Bibliography</li> </ul> <p>Document conventions:</p> <p>Designations indicated with brackets, e.g., " [A1] " preceding a section or paragraph title denote that explanatory material is provided in section 6.2.</p> <p>Designations indicated with brackets, e.g., " [B1] " preceding a section or paragraph title indicates that bibliography reference material is provided in section 6.4.</p>

This Page Intentionally Left Blank

## 2 APPLICABLE DOCUMENTS

### 2.1 General

Documents listed in this chapter are government and non-government reference documents that form a part of this standard and are applicable to the extent specified herein. While every effort has been made to ensure the completeness of this list, document users are cautioned that they shall meet all specified requirements of documents cited in Chapters 3, 4, and 5 of this standard, and national safety standards, whether or not they are listed.

- a. In the event of a conflict between the text of this standard and the references cited herein, the text of this standard takes precedence. Nothing in this standard shall supersede applicable laws and regulations unless a specific exemption has been obtained.
- b. Bibliography and reference source material is included in Chapter 6.

### 2.2 Government Documents

Due to periodic updating of government documents, the Contracting Officer and/or the Implementation Engineer shall specify the current version for project design or at contract award.

#### 2.2.1 FAA Specifications

FAA-C-1217	Electrical Work, Interior
FAA-G-2100	Electronic Equipment, General Requirements
FAA-STD-012	Paint Systems for Equipment

#### 2.2.2 FAA Orders and Handbooks

FAA-HDBK-010	Recommended Practices and Procedures for Lightning and Surge Protection, Grounding, Bonding, and Shielding Implementation
FAA-HDBK-011	Fundamental Considerations of Lightning Protection and Surge Protection, Grounding, Bonding, and Shielding

Copies of FAA specifications, standards, orders, and other applicable documents may be obtained from the Contracting Officer issuing the invitation-for-bid or request-for-proposal. Requests for this material should identify the material desired, for example, the specifications, standards, amendments, drawing numbers and dates. Requests should cite the use for the material, invitation-for-bid, request-for-proposal, the contract number, or other intended use.

#### 2.2.3 Military Documents

MIL-HDBK-232	Revision A Red/Black Engineering-Installation Guidelines
MIL-HDBK-237	Electromagnetic Compatibility Management Guide for Platforms, Systems and Equipment
DOD/MIL-HDBK-263	Electrostatic Discharge Control Handbook
DOD-STD-1686	Electrostatic Discharge Control Program for Protection of Electrical and Electronic Parts, Assemblies and Equipment (Excluding Electrically Initiated Explosive Devices)
MIL-HDBK-419	Grounding, Bonding, and Shielding for Electronic Equipment and Facilities

MIL-PRF-87893	Performance Specification, Workstation, Electrostatic Discharge Control
MIL-W-87893	Military Specification Workstation, Electrostatic Discharge (ESD) Control
MIL-STD-461	The Control of Electromagnetic Interference Emissions and Susceptibility
MIL-STD-889	Dissimilar Metals
MIL-STD-1686	Electrostatic Discharge Control Program for Protection of Electrical and Electronic Parts, Assemblies, and Equipment (Excluding Electrically Initiated Explosive Devices)
NACSIM 5203	Guidelines for Facility Design and Red/Black Installation (Confidential Document)
<p>Single copies of Military specifications, standards, and handbooks are available by mail or telephone from Document Automation and Production Service Customer Service, Standardization Documents Order Desk, 700 Robbins Avenue, Building 4D, Philadelphia, PA 19111-5094. <a href="http://quicksearch.dla.mil/">http://quicksearch.dla.mil/</a></p> <p>Not more than five items may be ordered on a single request and all requests must contain the document number. Only the latest revisions (complete with latest amendments) are available. Slash sheets must be individually requested. The Invitation for Bid or Contract Number should be cited where applicable.</p>	

### 2.3 Non-Government Documents

Due to periodic updating of non-government documents, the Contracting Officer and/or the Implementation Engineer must specify the current version for project design or at contract award unless a specific version is identified in this standard. These documents form a part of this standard and are applicable to the extent specified herein. While this standard may exceed the requirements of the following documents, building codes and industry standards always shall be followed as a minimum.

#### 2.3.1 Electronic Industries Alliance (EIA)

JEDEC Standard JESD625	Requirements for Handling Electrostatic-Discharge-Sensitive (ESDS) Devices
<p>Copies of EIA Standards are available from JEDEC Solid State Technology Association, Mailing Address: 3103 North 10th Street, Suite 240-S, Arlington, VA 22201-2107. <a href="https://www.jedec.org/">https://www.jedec.org/</a></p>	

#### 2.3.2 National Fire Protection Association (NFPA)

NFPA 70	National Electrical Code (NEC)
NFPA 77	Recommended Practice on Static Electricity
NFPA 780	Standard for the Installation of Lightning Protection Systems
<p>Copies of NFPA documents are available from the National Fire Protection Association, One Batterymarch Park, Quincy, MA 02269. <a href="http://www.nfpa.org">www.nfpa.org</a></p>	

### 2.3.3 Underwriters Laboratories (UL)

UL 96	Lightning Protection Components
UL 96A	Installation Requirements for Lightning Protection Systems
UL 779 (ANSI-A148.1)	Electrically Conductive Floorings
UL 1449	Standard for Surge Protective Devices
Copies of UL documents are available from Global Engineering Documents, 1500 Inverness Way, East Englewood, CO 80112. Telephone 303-397-7945, 800-854-7179. <a href="http://www.ul.com">www.ul.com</a>	

### 2.3.4 Institute of Electrical and Electronic Engineers (IEEE)

ANSI/IEEE C62.41.2	Recommended Practice on Characterization of Surges in Low-Voltage (1000 V and Less) AC Power Circuits
ANSI/IEEE C62.45	Recommended Practice on Surge Testing for Equipment Connected to Low-Voltage (1000 V and Less) AC Power Circuits
ANSI/IEEE 1100	Recommended Practice for Powering and Grounding Sensitive Electronic Equipment (Emerald Book)
Copies of IEEE documents are available from Institute of Electrical and Electronic Engineers, 445 Hoes Lane, P.O. Box 1331, Piscataway, NJ 08855-9916. <a href="http://www.ieee.org">www.ieee.org</a>	

### 2.3.5 Electrostatic Discharge (ESD) Association Documents

ESD ADV1.0	Electrostatic Discharge Terminology - Glossary
ESD ADV53.1	ESD Protective Workstations
ESD S4.1	Worksurfaces Resistance Measurements
ANSI/ESD S8.1	Symbols - ESD Awareness
ANSI/ESD S20.20	Development of an Electrostatic Discharge Control Program for Protection of Electrical and Electronic Parts, Assemblies and Equipment
ANSI/ESD STM 7.1	Floor Materials - Resistive Characterization of Materials
ANSI/ESD STM 11.11	Surface Resistance Measurement of Static Dissipative Planar Materials
ANSI/ESD STM 12.1	Seating - Resistive Measurement
ESD TR20.20	Handbook for the Development of an Electrostatic Discharge Control Program for the Protection of Electronic Parts, Assemblies and Equipment
ANSI/ESDA/JEDEC JS-001	ESDA/JEDEC Joint Standard for Electrostatic Discharge Sensitivity Testing - Human Body Model (HBM) - Component Level
Copies of ESD Association documents are available from the EOS/ESD Association, Inc. 7900 Turin Road, Building 3, Rome, NY 13440-2069. Telephone 315-339-6937. <a href="http://www.esda.org">www.esda.org</a>	

### 2.3.6 Telecommunication Industry Association (TIA) Documents

TIA-222	Structural Standard for Antenna Supporting Structures and Antennas
Copies of TIA documents are available from the Telecommunications Industry Association, 1320 North Courthouse Road, Suite 200, Arlington, VA 22201. Telephone 703-907-7700. <a href="http://www.tiaonline.org/standards/">www.tiaonline.org/standards/</a>	

This Page Intentionally Left Blank



### 3 DEFINITIONS

<b>A</b>	
Access Well	A covered opening in the earth using concrete or other cementitious material to provide access to an EES connection.
Armored Cable	Power, signal, control, or data cable having an overall armor or covering constructed of ferrous (steel) material that provides both structural protection and electromagnetic shielding for direct buried cables.
Arrester	Components, devices, and circuits used to attenuate, suppress, limit, or divert adverse electrical surge and transient energy. The terms arrester, suppressor, and protector are used interchangeably, except the term "arrester" is used herein for components, devices, and circuits installed on the primary side of FAA-owned distribution transformers.
<b>B</b>	
Bond	The electrical connection between two metallic surfaces used to provide a low-resistance path between them.
Bond, Direct	An electrical connection utilizing continuous metal-to-metal contact between the members being joined.
Bond, Indirect	An electrical connection employing an intermediate electrical conductor between the bonded members.
Bonding	The joining of metallic parts to form an electrically conductive path to ensure electrical continuity and the capacity to conduct current imposed between the metallic parts.
Bonding Jumper	A conductor installed to ensure electrical conductivity between metal parts required to be electrically connected.
Bonding Jumper, for NEC Compliance	See NEC definitions for power distribution wiring terms such as "Equipment", "Main", or "System" bonding jumper.
Branch Circuit	The circuit conductors between the final overcurrent protective device and the load.
Building "Structural" Steel	The main building structural steel members consisting of columns and beams or girders. Concrete-encased reinforcing steel rebars may be considered structural steel, depending on location.
Bulkhead Ground Plate	A metallic plate located where conduits, conductors, cables, waveguides, etc, enter the facility from the exterior. The bulkhead plate provides a central point for the grounding of these services to minimize external transients from entering the facility or structure.
Bushing	An insulated device that allows an electrical conductor to pass safely through a grounded conducting barrier such as the case of a panel, transformer, etc. The primary purpose is to prevent chafing of the conductors.
Bushing, Grounding or Bonding	An insulated device that allows for a grounding method at the end of the conduit. Also known as grounding-type bonding bushing or bonding bushing.
<b>C</b>	
Cabinet	An enclosure designed either for surface mounting or flush mounting that is provided with a frame, mat, or trim in which a swinging door or doors are, or can be, supported.
Cable	A fabricated assembly of one or more conductors in a single outer insulation. Types include axial, armored, and shielded.

FAA-STD-019f

Cable, AC	A fabricated assembly of insulated conductors in a flexible metallic enclosure. Type armored-cable (AC) cable is not the same as DEB cable.
Cable, Axial	Cable where all conductors are oriented on a single axis, such as coaxial, biaxial, and tri-axial cables.
Cable, Direct Buried	Cable with construction suitable for use in direct buried, underground installations without any form of conduit. Type direct buried cable is not the same as DEB cable.
Cable, Direct Earth Burial (DEB)	Cable with a ferrous shield designed to provide both physical and electromagnetic protection to the conductors.
Cable, MC	Metal-Clad Cable, Type MC. A factory assembly of one or more insulated circuit conductors with or without optical fiber members enclosed in an armor of interlocking metal tape, or a smooth or corrugated metallic sheath. See NEC.  <u>Note:</u> For the purpose of this standard, MC cable is only permitted when installed in accordance with FAA-C-1217.
Cable, Shielded	Cable with a metalized or braid shield to improve resistance to electromagnetic interference (EMI).
Case	A protective housing for a unit or piece of electrical or electronic equipment.
Chassis	The metal structure that supports the electrical or electronic components which make up the unit or system.
Conductor, Bare	An electrical conductor that has no covering or electrical insulation.
Conductor, Insulated	An electrical conductor encased within material of composition and thickness recognized by the NEC as electrical insulation.
Conductor, Lightning Bonding (Secondary)	An electrical conductor used to bond a metal object, within the zone of protection and subject to currents induced by lightning strikes, to the lightning protection system.
Conductor, Lightning Down	The down conductor serves as the path to the EES from the roof system of air terminals and roof conductors or from an overhead ground wire.
Conductor, Lightning Main	Conductors intended to carry lightning currents between air terminals and the EES. These can be conductors interconnecting air terminals on the roof, conductors connecting a metal object on or above the roof level that is subject to a direct lightning strike to the lightning protection system, or the down conductor.
Conductor, Lightning Roof	Roof conductors interconnecting all air terminals to form a two-way path to the EES from the base of each air terminal.
<b>E</b>	
Earth Electrode System (EES)	A network of electrically interconnected grounding systems such as ground rods, ground plates, ground mats, incidental electrodes including metallic piping and tanks, or ground grids installed below grade to establish a low resistance contact with earth.
Electromagnetic Interference (EMI)	Any emitted, radiated, conducted, or induced voltage that degrades, obstructs, or interrupts the required performance of electronic equipment.

Electronic Multipoint Ground System (MPG)	An electrically continuous network consisting of interconnected ground plates, equipment racks, cabinets, conduit junction boxes, raceways, duct work, pipes, copper grid system, building framing steel, and other non-current-carrying metal elements. It includes conductors, jumpers, and straps that connect individual electronic equipment components to the signal reference structure (SRS).
Electronic Single Point Ground System (SPG)	A discreet signal reference network that provides a single point of reference in the facility for electronic equipment which require single point grounding. It consists of conductors, plates, and equipment terminals, all of which are isolated from any other grounding system except at the main ground plate.
Enclosed Cable Tray	A cable tray with steel/aluminum sides and bottom with a steel/aluminum cover or lid.
Equipment	A general term including materials such as fittings, devices, appliances, fixtures, apparatus, and machines, used in conjunction with an electrical installation.
Equipment Areas	Areas that house electronic equipment used to support NAS operations, such as electronic equipment rooms, telephone company (TELCO) rooms, Very High Frequency Omni Directional Range (VORs), and Radars.
Equipment Grounding Conductor (EGC)	The conductive path installed to connect normally non-current-carrying metal parts of equipment together and to the system grounded conductor or to the grounding electrode conductor, or both. For FAA purposes, the EGC is to be green-insulated, solid or stranded, copper wire.
<b>F</b>	
Ferrous Conduit	Conduits composed of or containing iron, which are used to provide magnetic shielding, such as Rigid Galvanized Steel Conduit (RGS) or thick walled threaded conduit (NEC Rigid Metal Conduit-RMC).  <u>Note:</u> For the purpose of this standard, Electrical Metallic Tubing (EMT), Intermediate Metal Conduit (IMC), and conduits made from silicon bronze and stainless steel are not adequate for magnetic shielding protection.
Fitting, High Compression	See "Pressure Connector Terminations."
<b>G</b>	
Ground	A conducting connection, whether intentional or accidental, between an electrical circuit or equipment and the earth, or to a conducting body that serves in place of the earth.
Ground Dissipation Plate Design	Ground plate, refer to Figure 6.
Grounded	Connected to earth via a path of sufficiently low impedance and having sufficient current carrying capacity, such that fault current cannot build up voltage potentials that are hazardous to personnel.
Grounded Conductor	A system or circuit conductor that is intentionally grounded at the SDM or at the source of a separately derived system. This grounded conductor is the neutral conductor for the power system.
Grounding Conductor	A conductor used to connect equipment or the grounded circuit of a wiring system to a grounding electrode or electrodes.

FAA-STD-019f

Grounding Electrode	Copper rod, plate, or wire embedded in the ground for the specific purpose of dissipating electric energy to the earth. Also referred to as the Grounding Electrode System.
Grounding Electrode Conductor (GEC)	A conductor used to connect the system grounded conductor or the equipment to a grounding electrode or to a point on the grounding electrode system.
<b>H</b>	
High Frequency	All electrical signals at frequencies greater than 100 kHz, and pulse and digital signals with rise and fall times of less than 10 $\mu$ s.
High Transient Ground Plate	Entry or termination ground plate for connection of axial cable surge protection equipment and termination of cable shields, waveguides, conduits, and cable jackets. See Bulkhead Ground Plate.
Horizontal Transitions	Architectural term used to describe horizontal elements in a vertical structure, such as floor levels and stair landings.
Hydraulically Crimped Termination	Conductor termination using a hydraulic crimping tool that applies a 12-ton minimum compression force, using concentrically or circumferentially matching dies to form the connection.
<b>I</b>	
Inaccessible Location	A condition where gaining access to a system or part thereof requires significant effort, cost, or risk to personnel safety. Examples of such locations include below grade, behind walls and obstructions, or enclosed or concealed spaces that impede visual inspection.
<b>L</b>	
Landline	Any conductor, line, or cable installed externally above or below grade to interconnect electronic equipment in different facility structures or to interconnect externally mounted electronic equipment.
Low Frequency	Voltages and currents, whether signal, control, or power, up to and including 100 kHz. Pulse and digital signals with rise and fall times of 10 $\mu$ s or greater are considered to be low-frequency signals.
<b>M</b>	
Main Service Disconnect	A switch, fused switch, or circuit breaker that disconnects the main ac power service, generally utility power source, from a facility, located at the service disconnecting means (SDM).
<b>O</b>	
Office of Primary Responsibility (OPR)	The authority assigned to maintain and interpret this standard.
Operational Areas	Areas used to provide NAS support such as Instrument Flight Rules (IFR) rooms, Air Route Traffic Control Center (ARTCC) control rooms, ATCT tower cabs, operations control centers, and TRACON control rooms.
<b>P</b>	
Pressure Connector Terminations	Conductor termination using a mechanically bolted pressure connection.

<b>R</b>	
Rack	A metal frame in which one or more electronic equipment units are mounted.
Rigid Metal Conduit (RMC), Rigid Galvanized Steel Conduit (RGS)	A threaded raceway of circular cross-section designed for the physical protection, routing, and shielding of conductors and cables.
<b>S</b>	
Service Disconnecting Means (SDM)	Refer to the NEC definition for Service Point location.
Shield	A housing, shield, or cover that substantially reduces the coupling of electric and magnetic fields into or out of circuits or prevents accidental contact of objects or persons with parts or components operating at hazardous voltage levels.
Signal	Any electromagnetic transmission of information or control function. A signal can be analog, digital data, or a control function such as a relay closure.
Signal Reference Structure (SRS) System	The conductive terminal, wire, bus, plane, or network that serves as the relative zero potential for all associated electronic signals. Signal Reference Structures are required at locations or areas containing NAS electronic equipment.
Structure	Any fixed or transportable building, shelter, tower, mast, or other load-bearing system that is intended to house electrical or electronic equipment or otherwise support or function as an integral element of the air traffic control system.
Surface Resistivity	Surface Resistivity can be described as follows: For electric current flowing across a surface, the ratio of DC voltage drop per unit length to the surface current per unit width. In effect, the surface resistivity is the resistance between two opposite sides of a square and is independent of the size of the square or its dimensional units. Surface resistivity is expressed in ohms/square. See ESD ADV1.0 Glossary of Terms.
Surge	A short-term disturbance characterized by a sharp, brief discontinuity of a waveform. May be of either polarity and may be additive to, or subtractive from, the normal waveform.
Surge Protective Device (SPD)	A device intended to limit surge voltages on equipment by diverting or limiting surge current and is capable of repeating these functions as specified. SPDs are also commonly referred to as Transient Voltage Surge Suppressors (TVSS) or secondary surge arresters.
Susceptibility Level	The transient level on signal, control, or data lines that causes damage, degradation, or upset to electronic circuitry connected to the line.
<b>T</b>	
Transient	See Surge.
Transient Suppressor	Components, devices, or circuits designed for the purpose of attenuating, absorbing, and suppressing conducted transient and surge energy to protect facility equipment.
<b>Z</b>	
Zone of Protection	The space adjacent to a lightning protection system that has a reduced probability of receiving a direct lightning strike.

This Page Intentionally Left Blank

## **4 GENERAL REQUIREMENTS**

### **4.1 Introduction**

This chapter covers the common requirements and standard practice for the overall design, installation, construction, and evaluation of the following grounding systems in FAA facilities:

- a. Bonding Requirements
- b. Lightning Protection System Requirements
- c. Earth Electrode System (EES) Requirements
- d. National Electrical Code (NEC) Power Distribution System Grounding Compliance
- e. Surge Protective Device (SPD) Requirements
- f. Grounding and Bonding Requirements for NAS Electronic Equipment Areas
- g. Shielding Requirements
- h. Electrostatic Discharge (ESD) Requirements

### **4.2 Bonding Requirements**

The method of bonding, for the purpose of achieving electrical continuity, shall be in accordance with 4.2.1 through 4.2.5.

#### **4.2.1 General**

This section covers the following topics:

- a. Dissimilar Metals Compatibility Requirements
- b. Methods of Bonding
- c. Bonding Connection Installation Requirements
- d. Hardware for Bonding Jumpers and Straps

##### **4.2.1.1 [A1] Resistance of Bonds**

Unless otherwise specified in this standard, bonds shall have a maximum direct current (dc) resistance of 1 m $\Omega$  when measured between the bonded components with a four-terminal milliohm meter.

##### **4.2.2 Dissimilar Metals**

Bonding connections and associated fastener hardware for grounding system conductors shall comply with Table 1.

**Table 1. Mechanical Bonds Between Dissimilar Metals**

METAL	Copper, solid or plate	Brass and bronze	Stainless Steel	Tin-plate; tin-lead solder	Aluminum, wrought alloys of the 2000 Series	Iron, wrought, gray or malleable, plain carbon and low alloy steels	Aluminum, wrought alloys other than 2000 Series aluminum, cast alloys of the silicon type	Aluminum, cast alloys other than silicon type, plated and chromate	Galvanized steel	Zinc, wrought; zinc-base die-casting alloys; zinc plated
Copper, solid or plate	•••	•••	••	•	•	•	No	No	No	No
Brass and bronze	•••	•••	••	••	•	•	•	No	No	No
Stainless Steel	••	••	•••	•••	•••	••	•	•	No	No
Tin-plate; tin-lead solder	•	••	•••	•••	•••	••	••	•	No	No
Aluminum, wrought alloys of the 2000 Series	•	•	•••	•••	•••	•••	•••	••	•	•
Iron, wrought, gray or malleable, plain carbon and low alloy steels	•	•	••	••	•••	•••	•••	•••	•	•
Aluminum, wrought alloys other than 2000 Series aluminum, cast alloys of the silicon type	No	•	•	••	•••	•••	•••	•••	•	•
Aluminum, cast alloys other than silicon type, plated and chromate	No	No	•	•	••	•••	•••	•••	••	•
Galvanized steel	No	No	No	No	•	•	•	••	•••	•••
Zinc, wrought; zinc-based die-casting alloys; zinc plated	No	No	No	No	•	•	•	•	•••	•••
<b>LEGEND: Four Basic Categories of Possible Metal Interfaces</b>										
No	Not suitable. This interface is highly likely to result in significant corrosion.									
•	Suitable for indoor environments where temperature and humidity are controlled (non-condensing environment).									
••	Suitable for all indoor environment.									
•••	Suitable for all environments.									



### 4.2.3 Methods of Bonding

Direct bonding techniques include:

- a. Exothermic Welds. Exothermic welds are permitted for any type of bond connection specified herein.
- b. Hydraulically Crimped Terminations. Crimped terminations are permitted as an alternative technique to facilitate installation of connections in permanently concealed or inaccessible locations.
- c. Welded Assemblies. Metal fabrication assembly process constructed by welding the joints between the individual components.
- d. Mechanical Connections. Electrical bond connections constructed with bolted assemblies.
- e. Brazing and Soldering. Metal-joining process formed by brazing or soldering a filler alloy metal is not permitted for bond connections.
- f. Silver Soldering - Only Applicable for NAS Electronic Equipment. To improve conductivity, silver soft soldering material may be applied for the bonding of enclosure shielding joints already secured with mechanical fasteners. Mechanical fasteners shall be attached prior to application of solder to prevent cold solder joints. Soft soldering techniques are not permitted as a method for providing mechanical restraint.

#### 4.2.3.1 Exothermic Welds

Exothermic welded connections shall be provided for the following applications:

- a. Permanent Bonding. Permanent bonding of copper conductors to metal assemblies or building steel.
- b. Underground or Buried Locations.
- c. Exposed Exterior Locations. Any exposed location where an exothermic weld connection is possible.
- d. Permanently Concealed Locations. Locations where the connection will be permanently concealed after completion of fabrication or building construction process.
- e. Inaccessible Locations. Locations rendered inaccessible due to a building feature or other physical constraint that restricts routine access necessary to perform maintenance and visual inspection.

**Exception.** *Where exothermic welds are not possible due to dissimilar materials, incompatible shapes, voiding of a manufactured finish warranty, or in hazardous locations, such as near fuel tanks or other combustible material, provide UL listed hydraulically crimped or mechanical connections.*

##### 4.2.3.1.1 Exothermic Welds – Installation within Existing Facilities

The following measures shall be taken in the installation of exothermic welds within existing facilities:

- a. Where combustion from the use of a standard exothermic weld process would result in problems within the facility, a smokeless type exothermic weld process shall be provided.
- b. After completing the welding process, to prevent corrosion, remove or neutralize residual fluxes between components.

#### **4.2.3.2 Hydraulically Crimped Terminations**

A UL 467 and UL 96 listed irreversible compression type bonding connection is permitted for use within concealed and inaccessible locations.

- a. Bonding Conductors. Bonding conductors shall be wire size 6 AWG or larger.
- b. Hydraulic Compression Tool System. Hydraulic compression tool system shall be capable of producing a 12-ton minimum force applied with a tool using matching dies.

#### **4.2.3.3 Welded Assemblies**

Individual components of a welded assembly shall not require additional bonds between components if the dc resistance between individual components is less than 1 mΩ.

#### **4.2.3.4 Mechanical Bolted Bond Connections**

Mechanical bolted bond connections shall be prepared and completed in accordance with the installation conditions and requirements provided herein.

##### **4.2.3.4.1 [A2] Coupling of Dissimilar Metals**

Compression bonding with bolts and clamps shall comply with Table 1. When dissimilar base metals form couples that are not permitted per Table 1, the metals shall be coated, plated, or otherwise protected with a conductive finish.

##### **4.2.3.4.2 Bolted Connections**

Bonding bolts shall be used primarily as mechanical fasteners to hold electrical bonding components in place. Tighten bolts sufficiently to achieve adequate contact pressures for effective bonding, but do not overtighten them to the extent that deformation of bond members occurs. To prevent loosening of the connection, provide disc springs for connections using bolts 1/4-in. diameter and greater.

- a. Torque Requirements. Bolted connections 1/4-in. diameter and greater shall conform to the torque requirements in Table 2.
- b. Bolts, Nuts and Washers. Bolted connections in corrosive, damp, or wet locations, 1/4-in. diameter and greater, shall utilize stainless steel type 18-8 bolts, nuts, and load distribution washers. All other locations shall use corrosion-inhibited SAE Standard J429 Grade 5 nuts and bolts. Load distribution washers shall comply with ANSI B18.22.1 for stainless steel washers, Wide Series, Type B.
- c. Assembly. Bolted connections 1/4-in. diameter and greater shall be assembled in the order shown in Figure 1. Additional load distribution washers, if used, shall be positioned directly beneath the bolt head. Disc springs shall be between the nut and the

load distribution washer. Washers shall not be placed between bonded members. Load distribution washers shall be Wide Series, Type B.

- d. Termination Lugs. Provide 2-hole termination lugs for connections to ground plates. Provide 2-hole termination lug connections to equipment metal members for conductors size 6 AWG and larger. If the equipment metal members do not allow modification for installation of 2-hole lug terminations, then 1-hole termination lug are permitted.

#### **4.2.3.4.2.1 Sheet Metal Screws**

Sheet metal screws shall not be used to provide an electrical bond.

#### **4.2.3.4.2.2 Self-drilling and Self-tapping Screw Fasteners**

Self-drilling and self-tapping metal screws are permitted to make a physical connection between metal back panels within equipment cabinet/enclosures when access to the opposite side of the bond is not available using other bonding methods.

#### **4.2.3.4.3 Riveting**

Rivets shall be employed solely as mechanical fasteners to hold multiple smooth, clean metal surfaces together or to provide a mechanical load-bearing capability to a soldered bond.

**Table 2. Connection Torque Requirements for Bolted Bonds**

<b>Bolt Specification for Stainless Steel 301 Type SS 18-8</b>						
<b>Bolt diam. (in.)</b>	<b>Threads per inch</b>	<b>Torque (ft-lbs) SS 18-8</b>	<b>Bolt Clamp Load (lbs.)</b>	<b>Flat Load (lbs.)</b>	<b>Washers Required (see note 2)</b>	<b>Solon Part Number (see note 1)</b>
1/4	20	6	1,510	600	3	4-L-42-301
5/16	18	11	2,120	1,000	3	5-L-52-301
3/8	16	19	3,150	2,100	2	6-M-80-301
7/16	14	31	4,300	N/A	N/A	N/A
1/2	13	43	5,170	3,300	2	8-L-90-301
9/16	12	56	6,070	2,800	3	9-L-89-301
5/8	11	92	8,880	5,500	2	10-20-125-301
3/4	10	127	10,200	13,800	1	12-EH-168-177
7/8	9	194	13,310	14,400	1	14-H-168-177
1	8	286	17,200	14,200	2	16-H-187-177
<b>Bolt Specification for SAE J429 Type Grade 5</b>						
<b>Bolt diam. (in.)</b>	<b>Threads per inch</b>	<b>Torque (ft-lbs) Grade 5</b>	<b>Bolt Clamp Load (lbs.)</b>	<b>Flat Load (lbs.)</b>	<b>Washers Required (see note 2)</b>	<b>Rolex-Fastenal Part Number (see note 1)</b>
1/4	20	10	2,500	1,390	2	0124030
5/16	18	21	4,000	5,345	1	0124033
3/8	16	34	5,500	8,000	1	0124035
7/16	14	55	7,500	N/A	N/A	N/A
1/2	13	83	10,000	9,900	2	0124037
9/16	12	117	12,500	12,000	2	0124039
5/8	11	167	16,000	13,000	2	0124041
3/4	10	288	23,000	31,000	1	0124043
7/8	9	452	31,000	40,276	1	0124044
1	8	567	40,000	46,000	1	0124046
<b>Notes:</b>						
1. Other manufacturers of disc spring washers of equal or better performance are permissible. Use bolt assembly manufacturer's recommended torque values.						
2. The sum of the individual disc washer flat load ratings shall exceed the listed bolt clamp load. The number of washers required is calculated by the following formula:						
$B_{\text{Bolt Clamp Load}} < W_{\text{Number of Washers}} \times F_{\text{Washer Flat Load}}$						
For example, a 1/4-in. stainless steel bolted connection requires minimum 1,510 lbs clamp load, therefore, 3 disc washers will be needed.						

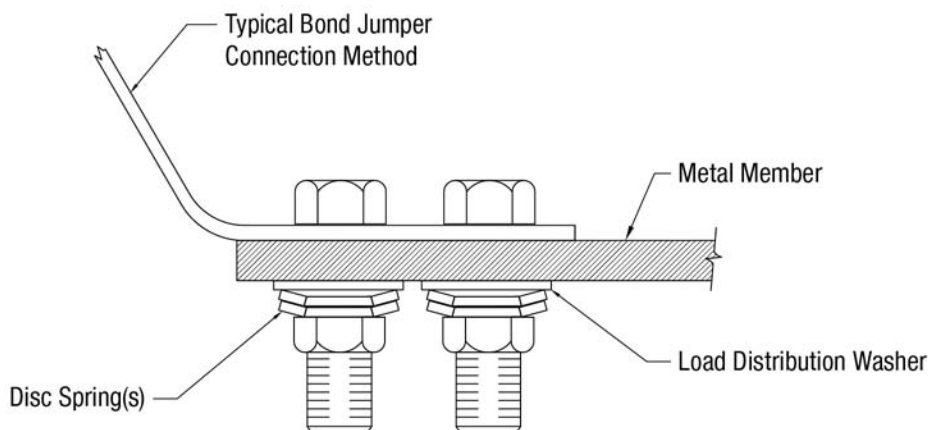

#### Notes:

1. Remove all paint on the entire bonding area of the metal member.
2. Stack disc spring washers to obtain required amount per Table 2.
3. Provide 2-hole termination lugs for connections to ground plates.

**Figure 1. Order of Assembly for Bolted Connections**

#### 4.2.4 Bonding Connections – Installation Requirements

Bonding connections shall be prepared and completed in accordance with the installation conditions and requirements provided herein.

##### 4.2.4.1 Surface Preparation

Bonding surfaces shall be cleaned thoroughly and free of dirt, dust, grease, oxides, nonconductive films, and foreign material. Paint and other coatings at the location shall be removed to expose the base metal.

- a. Surface Area To Be Cleaned. Clean mating surfaces at least 1/4-in. beyond each side of the smaller bonded area.
- b. Clad Metals. Clean clad metal to a bright, shiny, smooth surface without penetrating the cladding. Wipe the cleaned area with solvent and allow the surface to air dry before completing the bond.
- c. Aluminum Alloys. To create a bright finish after cleaning, apply a conductive coating with paint or resin finish to aluminum mating surfaces.

##### 4.2.4.2 Completion of Bonding Connection

Clean surfaces with a solvent suitable for electrical work immediately prior to assembly. Mating surfaces shall be joined within 2 hours after cleaning if an intentional protective coating has been removed from the metal surface. If delays beyond 2 hours are necessary in corrosive environments, then the cleaned surfaces shall be protected with an appropriate coating that shall be removed prior to completion of the bond connection.

- a. Refinishing of Bond. Areas around the bond connection shall be restored to match the original finish, unless not feasible.

- b. Surface Plating or Treatments. Surface plating or treatments may be applied to the connection to improve abrasion resistance and corrosion protection, provided the treatment material enhances bond conductivity. Silver and other easily tarnished metals shall not be used to plate bonded surfaces, except where use of other metals may result in an unacceptable increase in surface contact resistance. In such cases, protect plating material by sealing exposed surfaces of the completed connection from the atmosphere.

#### **4.2.4.3 Sealing and Finish Treatments for Bonding Connections**

All bonds shall be protected against weather, corrosive atmospheres, vibration, and mechanical damage. Under dry conditions, apply a compatible corrosion preventive or sealant within 24 hours of assembly of the bond materials. Under conditions exceeding 60 percent humidity, seal the bond with a compatible corrosion preventive or sealant within 1 hour of joining.

Exterior bonds shall be protected against corrosion. Interior bonds exposed to moisture or high humidity shall be protected against corrosion.

- a. Sealing Treatment for Corrosion Protection. Corrosion protection shall be provided by sealing the bond connection with a moistureproof paint conforming to FAA-STD-012 or with a silicone or petroleum based sealant to prevent moisture from reaching the bonding area. Bonds protected by conductive finishes such as alodine and iridite shall not require painting to meet the requirements of this standard.
- b. Compression Bonds in Climatically Protected Areas. Sealing is not required for compression bonds between copper conductors or compatible aluminum alloys that are located in readily accessible areas that are not exposed to moisture, corrosive fumes, or excessive dust.
- c. Painted Finishes. If a paint finish treatment is required on the final assembly, then the bond shall be sealed in accordance with the manufacturer's recommendation. To ensure the bond is completely sealed against moisture, a waterproof type of paint or primer shall be used if the recommended finish treatment is not waterproof.

#### **4.2.5 Bonding Connections – Hardware for Bonding Jumpers and Straps**

Bonding jumpers and straps shall be installed in accordance with the requirements provided herein.

##### **4.2.5.1 Installation of Bonding Jumpers**

Bonding jumpers shall be insulated conductors, except as noted herein.

Bare conductors shall be used for the following applications:

- a. Raised access floor installations.
- b. Jumpers for structural steel or rebar connected to the EES, lightning protection systems, and plenums or environmental air spaces.
- c. Jumpers too short to be insulated or where required by NEC.

#### **4.2.5.2 Installation of Bonding Straps**

Bonding straps for bonding of electronic equipment shall be as short as possible. Herein, bonding straps are expected to be bare.

Bonding straps shall conform to the following:

- a. Bonding straps shall be attached to the integral structural frame portion of the cabinet/enclosure rather than through adjacent parts to achieve optimal electrical connection.
- b. Bonding straps shall be installed so that the electrical bond is not affected by motion or vibration.
- c. Bonding straps shall be installed wherever possible in areas accessible for maintenance and inspection.
- d. Bonding straps shall be installed to allow movement of the components being bonded or other adjacent components intended to move as part of normal functional operation.
- e. Two or more bonding straps shall not be connected in series to provide a single bonding path.
- f. The method of installation and point of attachment of bonding straps shall not weaken the components to which they are attached.
- g. Bonding straps shall not be compression fastened through nonmetallic material.
- h. Bonding installed across shock mounts or other suspension/support devices shall not restrict the performance of the mounting device. Bonding connections shall be capable of withstanding anticipated motion and vibration of supports without suffering metal fatigue, loosening of ground connections, or other degradation.

#### **4.2.5.3 Fastener Hardware**

Fastener materials for attachment of bonding straps and jumpers to structures shall conform to materials listed in Table 1.

#### **4.2.5.4 Temporary Bonding Connections**

Alligator clips or spring-loaded clamping products are permitted only for the purpose of establishing a temporary bond connection while performing repair work on equipment or facility wiring.

### 4.3 Lightning Protection System Requirements

#### 4.3.1 General

The purpose of the lightning protection system is to provide preferred paths for lightning discharges to enter or leave the earth without causing damage to facility or equipment or injury to personnel. The essential components of a lightning protection system are air terminals and roof and down conductors connecting to the EES, the EES, and SPDs. These components act together as a system to dissipate lightning energy. The lightning protection system shall meet or exceed the requirements of FAA standards and orders as specified herein and the following:

- a. Standard for the Installation of Lightning Protection Systems (NFPA 780)
- b. Installation Requirements for Lightning Protection Systems (UL 96A)

The risk assessment guide in NFPA 780 indicates that many NAS facilities have a high risk index. Accordingly, lightning protection requirements that exceed the minimum requirements of NFPA 780 are specified herein. Inclusion of a UL Master label is not sufficient to indicate compliance with this standard.

- a. ATCT Special Requirements. See section 5.2 for Airport Traffic Control Tower (ATCT) special requirements.
- b. Other Special Conditions. See section 5.3 for other lightning protection system special conditions.

#### 4.3.2 Lightning Protection System – Components

Products shall be UL listed and labeled with the UL certification mark in accordance with UL requirements. All equipment shall be new and of adequate design and construction to suit the application in accordance with UL 96A requirements. Provide copper or tinned copper cable materials. Aluminum cables shall only be used on aluminum and galvanized surfaces. Bimetallic connectors shall be used for interconnecting copper and aluminum conductors. Dissimilar materials shall conform to the bonding requirements of paragraph 4.2.2.

#### 4.3.3 Lightning Protection System – Material Class Requirements

The FAA has opted to exceed minimum NFPA 780 cable sizing requirements. Provide Class II or larger rated materials, as specified in NFPA 780, for the following:

- a. Air Terminals
- b. Main and Down Conductors
- c. Bonding Conductors

#### 4.3.4 Lightning Protection for NAS Facilities Buildings and Structures

Lightning protection shall be provided for buildings and structures, or parts thereof that are not within the zone of protection provided by another building, higher part of a building, an antenna, or a tower. The zone of protection scheme for all structures shall be as defined in NFPA 780.

##### 4.3.4.1 Number of External Down Conductors for Buildings

The number of down conductors shall be based on both the building height and perimeter.



- a. Buildings and Structures Less Than 60 ft High Above Grade. These buildings and structures measured to the highest point of the building or structure shall have at least two down conductors.
- b. Buildings and Structures More Than 60 ft High. See section 5.2.2.
- c. Buildings and Structures with Perimeters in Excess of 250 ft. These buildings and structures shall have one additional down conductor for each 100 ft of perimeter distance or part thereof. Down conductors shall be as widely separated as possible, e.g., at diagonally opposite corners on square or rectangular buildings.

#### **4.3.4.2 Metal Parts of Buildings**

Building steel, metal roofing, metal supporting structures, concrete reinforcing steel, siding, eave troughs, down spouts, ladders, duct, and similar metal parts shall not be used as substitutes for roof or down conductors. A lightning protection system shall be applied to the metal roof and metal siding of a metal clad building in the same manner as on a building without metal covering. Building metal parts shall be bonded in accordance with paragraph 4.3.8.

***Exception.*** See paragraph 5.2.2.3b for ATCT lightning protection system design requirements.

#### **4.3.4.3 Roof-Mounted Antenna Masts**

Unless it is a radiating or receiving part of the antenna, the metallic mast of a roof-mounted antenna shall be bonded to the nearest main roof conductor or down conductor.

- a. If a main roof conductor or down conductor is not available where an antenna is installed on top of an ATCT, then bond the antenna mast to building steel in lieu of the EES. Reinforcing bars shall not be used in lieu of building steel.
- b. If an antenna is installed on top of a building or base building, and the path is longer than a tenth of the difference between building steel and the EES (i.e. building steel is 5 feet away and the EES is more than 50 feet away), then bond the antenna mast to building steel. Reinforcing bars shall not be used in lieu of building steel.

#### **4.3.5 Lightning Protection System - Conductor Routing**

Down conductors shall follow the most direct downward path to earth. Main and bonding conductors shall maintain a downward or horizontal course, and are permitted to rise at no greater than a 1 to 4 slope.

- a. Conductor Bends. Down conductors shall be installed without any sharp bends or kinks. No bend in a main and bonding conductor shall form an included angle of less than 90 degrees, nor shall it have a bend sweep radius of less than 8 in.
- b. Conductor Connections. T-style and cross-over cable-to-cable connections between main conductors shall be in accordance with Figure 2.
- c. Conductor Routing. Conductors shall be routed outside of structures and not penetrate structural cladding except as indicated in 5.2.2.3b. Conductors shall be routed 6 ft or more from power or signal conductors. If this clearance cannot be met, the power and signal conductors shall be routed in ferrous RGS conduit or enclosed ferrous cable tray.

- d. Main Conductors. Main conductors shall be permitted to pass through elements of the building structure, e.g., parapets, eaves, walkways, walls, where necessary to maintain horizontal or downward course. Provide a 2-in., Schedule 80 rigid PVC conduit sleeve, or UL listed through-connector fitting at penetrations. When the conductor penetrates a metallic structure of any thickness, the conductor shall be bonded to the metallic structure. Conductors are permitted to pass through metal gratings or plates without a conduit sleeve; however, the conductor shall be bonded to the metallic structure.

#### **4.3.5.1 Main and Down Conductor Terminations to EES**

Conductor terminations to the EES shall be exothermically welded to a 4/0 AWG copper conductor prior to entering the ground at not less than 18 in. above grade. The 4/0 AWG copper conductor shall be bonded directly to a ground rod or electrode conductor in the EES. Exothermic weld connections to the EES shall be in accordance with Figure 3.

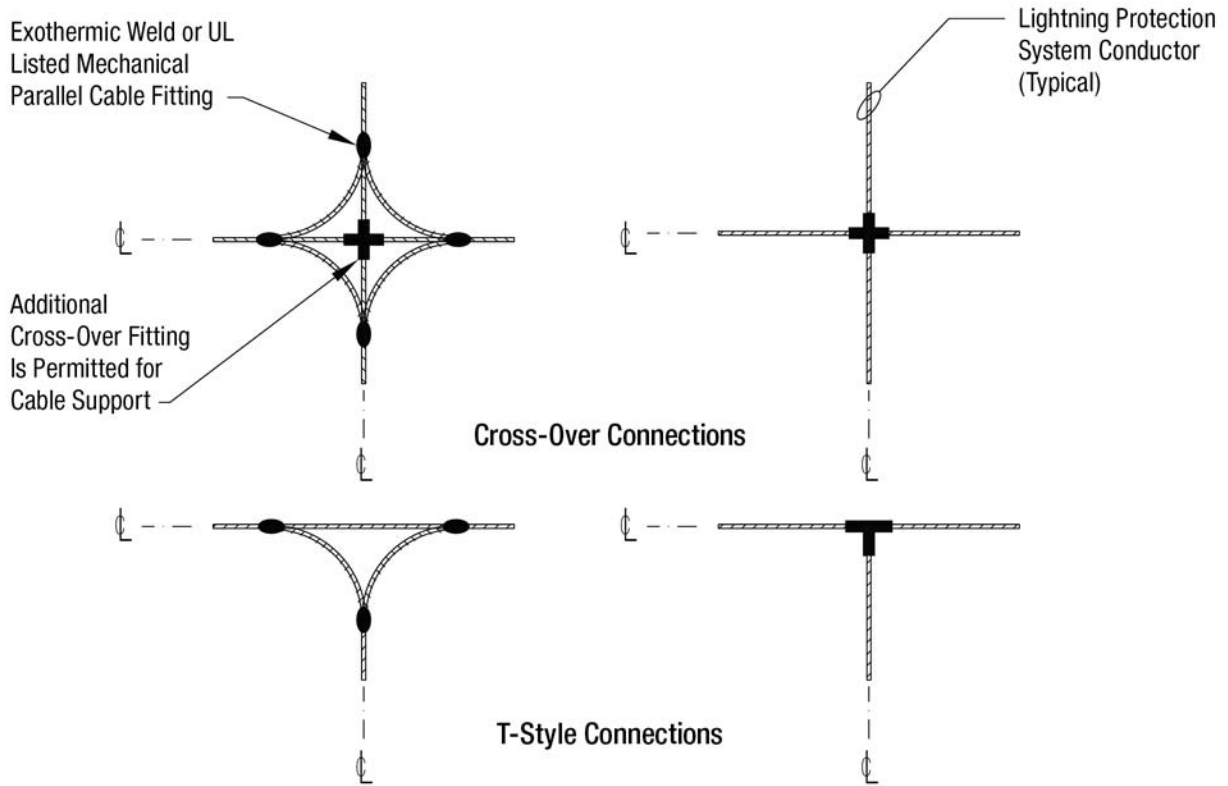

**CABLE-TO-CABLE HORIZONTAL AND VERTICAL CONDUCTOR CONNECTIONS**

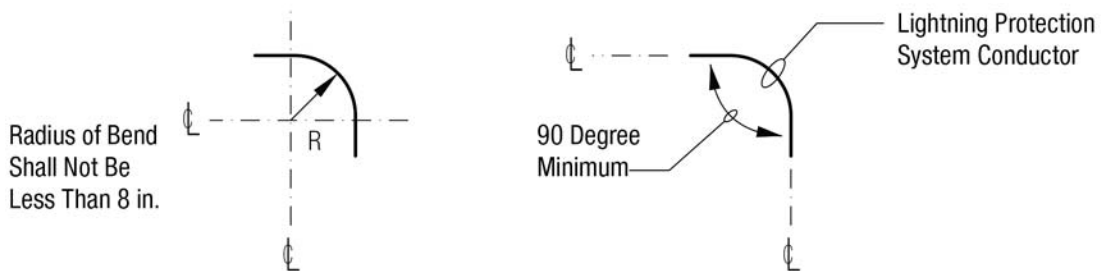

**CONDUCTOR BENDING REQUIREMENTS**

**Figure 2. Lightning Protection System Main Conductor Connections – Illustrative Example**

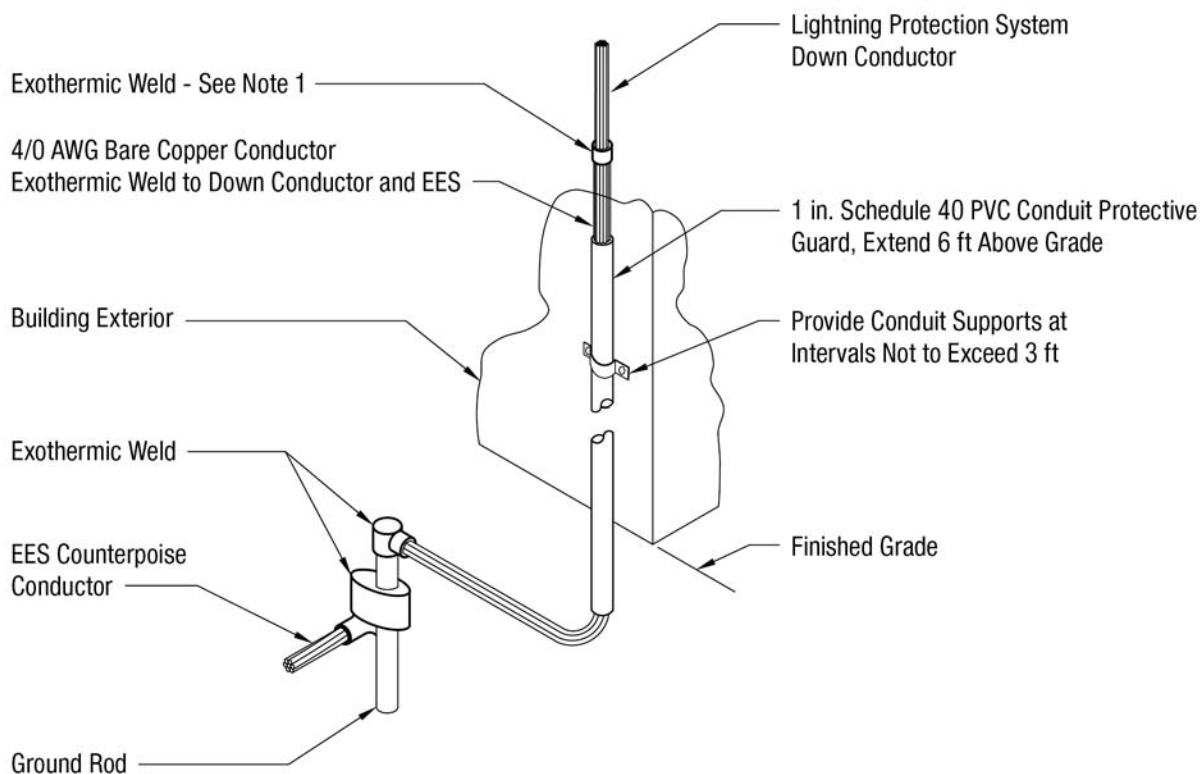

Note:

1. Locate exothermic weld above the conduit guard to ensure connection is available for visual inspection. When installation of the connection is not possible at top of conduit guard, locate the exothermic weld at least 18 in. above finished grade and provide guard system with pull box and removable cover that will permit visual inspection of the weld connection.

**Figure 3. Main and Down Conductor Termination to EES – Illustrative Example**

**4.3.6 Lightning Protection System - Air Terminals**

Air terminals shall be solid copper, bronze, or aluminum. Air terminals shall be stainless steel in areas of high potential for corrosion. Copper air terminals shall be allowed to have nickel plating. Air terminals shall be 12-in. high minimum, with a diameter of at least 1/2-in. for copper and 5/8-in. for aluminum, and have sharp, blunt or approved protective style tip. Air terminals shall be located and installed in accordance with NFPA 780 and UL 96A, and as required herein. Closer spacing is permitted for unique geometries. Air terminals shall extend at least 10-in. above the object or area it is to protect.

Air terminals located near working or walking surfaces may present an impalement hazard to personnel. The impalement protection design may be accomplished through use of air terminal selection, air terminal mounting type, mounting height, or a combination thereof. If mounting height is selected to mitigate the impalement hazard, the top of the air terminal shall not be less than 5-ft above the adjacent walking surface. If it is not feasible to install the air terminal on the

object, locate air terminals next to the object to achieve this requirement, and bond the metallic object to the lightning protection system.

#### **4.3.6.1 Mast Poles Used For Air Terminal Installation**

Air terminals installed on mast poles shall be at least 2 ft tall and extend a minimum of 10 in. above the top of the mast pole. Provide a down conductor installed on the exterior of the mast pole. Air terminal and down conductor shall be fastened to the pole in accordance with NFPA 780. Connect air terminal to the nearest main roof conductor or down conductor. If a roof or down conductor is not available, bond directly to the EES.

#### **4.3.7 Lightning Protection System - Hardware**

Lightning protection system hardware and installation shall be prepared and completed in accordance with the installation conditions and requirements provided herein.

##### **4.3.7.1 Fastener Hardware**

Provide conductor fasteners at intervals in accordance with NFPA 780. Provide fastener material using the same base material as the system conductor, or a material equally resistant to corrosion as the system conductor.

- a. Plastic, Galvanized, or Plated Materials. Not permitted.
- b. Fasteners. Where fasteners are part of a bonding connection component, the bonding surface shall be prepared and protected in accordance with paragraph 4.2.4. Cable holders that do not have mechanical support such as products with fold-over or break-away tabs shall not be used.

##### **4.3.7.2 Terminations and Fittings**

The preferred method for conductor connections and terminations is by exothermic welding. Where mechanical bolted pressure termination fittings are used the bonding devices, conductor splices, conductor terminations, and connectors shall be compatible with the installed conductor. Provide stainless steel, copper, bronze, or aluminum termination materials in accordance with the following:

- a. Materials. Fitting material shall be suitable for use with the system conductor.
- b. Straight and 90 Degree Through-Connectors. UL listed straight and 90 degree through-connectors are permitted to facilitate horizontal and vertical routing of system conductors.

##### **4.3.7.3 Conductor Protective Guards**

Provide protective guards for system down conductors located in or next to driveways, walkways, or other areas where they are subject to damage or displacement.

- a. Nonmetallic Guards. Provide nonmetallic conductor guards, schedule 40 polyvinyl chloride (PVC) conduit or equivalent.
- b. Guard Installation. Install guard from 1 ft below grade level extending to 6 ft above grade. When the roof or roof soffit construction is within 2 ft of the guard, the protective guard may be lowered to facilitate termination of the down conductor.

***Exception.*** Metal guards are permitted in lieu of nonmetallic material; however, metal guards shall be bonded to the down conductors at both ends of the guard. Provide bonding conductor size equal to the down conductor size.

#### **4.3.8 Lightning Protection System – Bonding Connections**

Bonding connections shall be prepared and completed in accordance with the installation conditions and requirements provided herein. Provide exothermic welds for conductor connections to the EES.

##### **4.3.8.1 Metallic Bodies Subject to Direct Lightning Strikes**

Metallic bodies and assemblies that protrude beyond the zone of protection provided by the installed air terminals are subject to direct lightning strikes. This includes but is not limited to roof drains, gutters, vents, canopies, electrical raceway and fixtures, pipes, exhaust fans, metal cooling towers, HVAC units, ladders, railings, antennas, structures with metal louvers, etc.

Provide lightning protection for metallic bodies and assemblies for the following conditions:

- a. Electrically Continuous Assemblies.
  1. Where metal thickness is 3/16 in. or greater, bond the assembly to the nearest lightning protection system main conductor. Provide fitting with bonding surface of at least 3 in.<sup>2</sup>
  2. Where metal thickness is less than 3/16 in., install air terminals, main conductors, and fittings to provide at least two paths to ground from each air terminal device.
- b. Not Electrically Continuous Assemblies. If the assembly consists of segmented parts and is not electrically continuous, then provide an additional main conductor interconnected to the nearest lightning protection system. Bond the individual metal parts. Provide at least two paths to ground.

##### **4.3.8.2 Metallic Bodies Subject to Induced Charges**

Metallic bodies that are subject to induced charges from lightning, including those in a zone of protection, shall be bonded to the lightning protection system in accordance with NFPA 780. This includes, but is not limited to, roof drains, vents, coping, flashing, gutters, downspouts, doors, door and window frames, balcony railing, conduits, and pipes, etc.

##### **4.3.8.3 Metallic Bodies – Special Conditions**

Metallic bodies located at grade or outside the lightning protection system's zone of protection may be bonded by direct connections to the EES.

###### **4.3.8.3.1 Exhaust Stack Grounding**

Fossil fuel exhaust stacks shall be bonded to the nearest lightning protection system main conductor or directly to the EES, using a bonding conductor of greater than or equal size as the main conductor. Provide exothermic weld or mechanical connection at exhaust stack, and exothermic weld at EES.

When the exhaust stack is located farther than 6 ft from a main conductor and, the exhaust stack shall be bonded directly to the EES.

**4.3.8.3.2 Fuel and Oil Storage Tanks**

Provide exothermic welds to bond tank vent piping and assemblies to the EES. Mechanical bonds may be used where required for dissimilar metals or component compatibility at the tank assembly. Bond tank vent piping and assemblies in accordance with following:

- a. Above-Ground Nonpressurized Fuel and Oil Tank Vent Piping. Bond above-ground tank vent piping directly to the EES using a bonding conductor of greater than or equal size as the lightning protection system main conductor.
- b. Above-Ground Tank Assemblies. Provide at least two easily accessible and widely separated grounding points for the tank assembly. Bond each grounding point directly to the EES using a 2/0 AWG conductor. Bond other metallic components, e.g., stairs, ladders, or skids, with a 2/0 AWG copper conductor.
- c. Above Ground Pressurized Fuel Tanks. For pressurized fuel tanks, e.g., propane and compressed natural gas, provide at least one bond connection from tank mounting supports connected directly to the EES using a 2/0 AWG copper conductor.
- d. Indoor Fuel and Oil Tank Vent Piping. Bond indoor mounted engine-generator day tank or other metallic fuel storage system vent piping mounted on the building exterior in accordance with NFPA 780.
- e. Secondary Containment Systems. Secondary containment for fuel piping shall be bonded directly to the EES.

## 4.4 Earth Electrode System (EES)

### 4.4.1 General

An EES shall be installed at each facility to provide a common point of reference for all grounded systems at the facility. The EES establishes a low resistance to earth for lightning discharges, electrical and electronic equipment grounding, and surge/transient protection. The EES shall be capable of dissipating within the earth the energy of direct lightning strikes with no ensuing degradation to the system itself. The EES shall dissipate dc, ac, and radio frequency currents from equipment and facility grounding conductors.

### 4.4.2 [A3] Site Survey and Geotechnical Investigation

A subsurface geotechnical investigation shall be required to establish the design approach and parameters for new building construction to determine soil composition and resistivity characteristics. Information to be collected shall include location of rock formations, gravel deposits, soil types and classifications, and moisture content. The survey data shall be noted on a scaled drawing or sketch of the site, and documented in the Facility Reference Data File (FRDF). Soil resistivity testing shall be in accordance with FAA-HDBK-010.

### 4.4.3 EES – Design

The EES normally consists of driven ground rods, buried interconnecting conductors, and connections to underground metallic pipes, excluding gas lines and fuel tanks. The site survey and geotechnical investigation shall be used as the basis for the design of new buildings. The design objective for the EES resistance to earth shall be as low as possible, but shall not be greater than 10  $\Omega$ . Where “poor soil” conditions are encountered such as surface rock, shallow soils, permafrost, soils with low moisture, or high mineral content, then grounding enhancement methods listed in paragraph 4.4.5 shall be considered.

### 4.4.4 EES - Configuration

The EES shall consist of a continuous buried counterpoise conductor loop that extends around the entire perimeter of the facility or building structures. Provide ground rods interconnected along the counterpoise loop, spaced at least one ground rod length apart. Refer to FAA-HDBK-010 for design considerations.

For sites comprising multiple building structures, such as a building and antenna tower, configure the EES based on the following facility separations:

- a. Less than 15 ft. A single EES loop designed to encircle the adjacent facilities is permitted.
- b. Greater than 15 ft but Less than 30 ft. Design a separate EES for each facility, where adjacent EES loops may share a common side.
- c. Greater than 30 ft but Less than 100 ft. Design a separate EES loop for each facility. Interconnect all EES loops by a minimum of two buried conductors, separated as widely as possible.
- d. Greater than 100 ft. Design a separate EES for each facility. Interconnection of the separate EES is not required.



For small facilities, such as airfield navigation aids (NAVAIDS) or outdoor equipment service racks illustrated in Figure 4, an alternative EES design consisting of a minimum of two ground rods with a 4/0 AWG interconnecting ground wire is permitted.

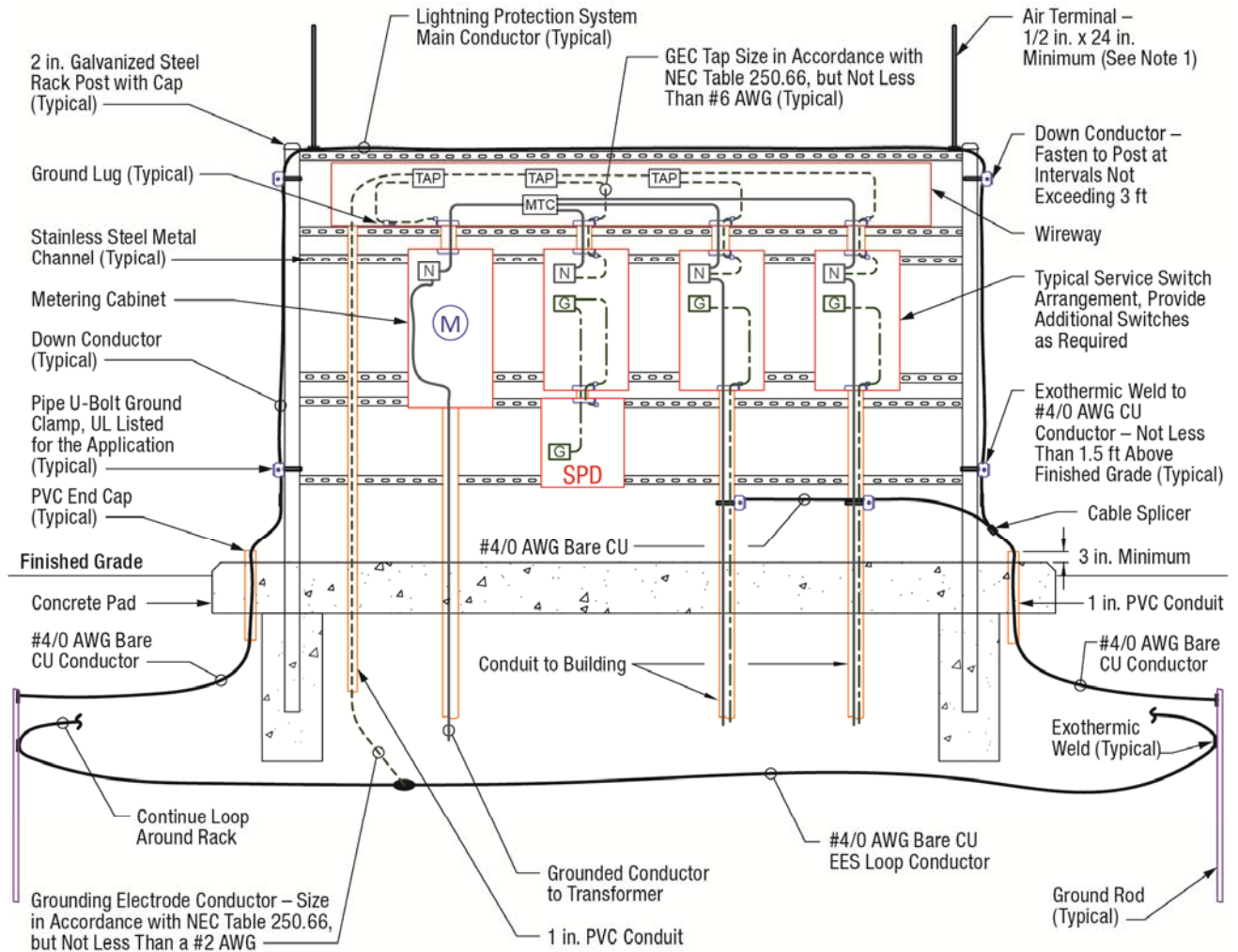

Notes:

1. Only one air terminal, mounted at the center of the rack, is required for racks less than 6 ft in width.
2. Drawing is diagrammatic, phase conductors are not shown for illustrative purposes.

**Figure 4. Typical Service Rack EES Installation – For Illustrative Purposes Only**

**4.4.4.1 Ground rods**

Installation of ground rods shall meet the following requirements:

- a. Material and Size. Ground rods shall be copper or copper clad steel, a minimum of 10 ft long and 3/4 in. diameter. Rod cladding shall not be less than 1/100 in. thick.
- b. Spacing. Ground rods shall be as widely spaced as possible, and in no case spaced less than one rod length. Nominal spacing between ground rods is between two and three times the rod length.
- c. Depth of Rods. Install top of ground rods at least 1 ft below grade level, or 1 ft below frost depth if required to suit climatic conditions.
- d. Location. Rods shall be located 2 to 6 feet beyond the foundation or exterior footing of the structure, except at locations where abutting sidewalks, equipment, or other obstructions warrant locating rods farther away from the foundation. On buildings with overhangs or sidewalks in close proximity, then the ground rods are permitted to be placed at locations further out.
- e. Orientation. Ground rods shall be driven at 90 degree (vertical) orientation to finish grade. If ground rods cannot be driven vertically to their full length, then the installation of grounding dissipation plates needs to be considered.

**4.4.4.2 Interconnections**

The EES installation shall include the following:

- a. Counterpoise Loop. Ground rods shall be interconnected by a direct buried, bare 4/0 AWG copper conductor installed at least 2 ft below grade. Locate the counterpoise conductor and ground rods below the minimum frost depth. The interconnecting conductor shall close on itself forming a complete loop with the ends exothermically welded. Locate the counterpoise conductor and ground rods below the minimum frost depth with the exception of permafrost.
- b. Exothermic Welds. Provide exothermic weld connections, except where prohibited by the NEC and at locations where welding creates hazards, such as near fuel tanks. In these cases, connections shall be installed with hydraulically crimped terminations using 12-ton minimum force applied with a tool using matching dies.
- c. Building Structural Steel. Building perimeter steel columns shall be bonded to the EES at spacing intervals of approximately every other column, but not more than 60-ft intervals.
- d. Reinforced Concrete Structures. Bond reinforcement bars to the EES once every 60 linear feet along the building foundation perimeter with a minimum 4/0 AWG bare stranded copper conductor exothermically welded or by a hydraulically crimped termination.
- e. Underground Metallic Structures. Bond underground metallic pipes and tanks, except where cathodic protection systems are used or where prohibited by the NEC, such as gas piping.

- f. Telephone Ground. Where present, the ground shall be connected to the EES by a bare copper conductor not smaller than 2 AWG.

#### 4.4.4.3 Ground Dissipation Plates

In shallow soil locations with limited surface space, ground dissipation plates are permitted in lieu of ground rods in the EES. In difficult soils/areas, a combination of trenches filled with metallurgical coke and ground dissipation plates is highly recommended.

Installation of ground dissipation plates shall meet the following requirements:

- a. Dissipation Plate Surface Area. Ground dissipation plates have four times the surface area of one ground rod, 3/4 in. diameter and 10 ft long. Therefore, substitute one ground dissipation plate for four ground rods.
- b. Material and Size. Plates shall be fabricated and installed in accordance with Figure 6.
- c. Spacing. Nominal spacing is 100 ft between ground plates.
- d. Depth of Plates. Install plates to the same depth or deeper than the interconnecting EES counterpoise conductor, but maintain a minimum of 1 ft of native soil above the upper edge of the plate.
- e. Location. The plates shall be installed at the corners of the EES at the farthest accessible point from the facility to be protected.
- f. Orientation. Plates should be installed in a vertical plane to take advantage of seasonal moisture and temperature changes in the soil.

#### 4.4.4.4 [A4] Access Well

Access wells are permitted to enable inspection and maintenance activities. When installed, the well should be located at a ground rod in unpaved areas with access to open soil, to allow for inspection. The access well shall be made from concrete or other approved material, with a removable cover. The access well shall provide a 12-in. minimum radius clearance from the center of the ground rod to the inside wall of the access well.

### 4.4.5 Grounding Enhancement Materials for Earth Electrode System (EES) Installation

Enhancement materials and methods are listed in order of preference.

#### 4.4.5.1 Metallurgical Coke

Metallurgical coke is a steelmaking byproduct material of coal-to-coke production. Metallurgical coke is environmentally safe, stable, and conductive even when completely dry or frozen, moisture independent, compactable and economical to install.

Normal installation is in a 1-ft square trench filled with metallurgical coke in an EES configuration with a continuous 4/0 AWG stranded copper conductor in the center of the material per Figure 5. The top of the metallurgical coke trench shall be covered by a minimum of 1 ft of native soil. Metallurgical coke shall contain no more than 1 percent sulfur by weight. Charcoal and/or petroleum-based coke breeze shall not be substituted for metallurgical coke derived from coal in coke ovens. Charcoal and petroleum coke typically contain high levels of sulfur, which in the presence of moisture will accelerate corrosion of the EES. Placement of the

trench is based on the geometry of the facility and the physical site location. Radial trenches with a center conductor can be used to enhance RF ground planes in communication facilities.

#### **4.4.5.2 Engineered Soil Materials**

Engineered soil materials are cements, soils, or clays treated with a variety of materials to enhance soil conductive properties. These materials may be used in bored holes for ground rod installations and in trenches for counterpoise conductors. These engineered soils can be a mixture of moisture-absorbing materials such as Bentonite or homogenous clays in combination with native soils and/or chemicals. Some engineered soil enhancements use cement-based materials, but should be avoided in areas subject to significant soil movement. Engineered soil should have a moisture content of greater than 14 percent to be effective.

#### **4.4.5.3 Chemical Soil Enhancements**

Chemical enhancements (doping) using materials such as mineral salts, Epsom salts, and sulfates, should only be used as a last resort to enhance soil conductive properties. These materials may be used in bored holes for ground rod installations and in trenches for counterpoise conductors. Chemical enhancement is dependent on soil moisture content and requires periodic (usually annual) re-treatment and continuous monitoring to be effective. The chemicals can leach into the surrounding soil and can be deposited into the water table.

#### **4.4.5.4 Chemical Ground Rods.**

Similar to chemical enhancements, chemical ground rods also require re-treatment and monitoring to ensure continuous effectiveness. Many of these systems require a drip irrigation system in dry soil conditions. Installation and periodic inspections shall be in accordance with manufacturer's instructions.

#### **4.4.6 Installation of Earth Electrode Systems in Corrosive Soils**

Careful consideration must be given to the installation of any grounding system in soils with corrosive elements. Two geological areas of known concern are the volcanic soils in Hawaii and Alaska. It is recommended that supplemental cathodic protection be applied to the grounding system at these locations. A buried steel plate acting as a sacrificial anode shall be connected to the EES by a 4/0 AWG stranded bare copper conductor. The 4/0 AWG conductor shall be exothermically welded to the EES and to the sacrificial plate. The conductor shall be welded to the center of the plate. The sacrificial plate shall be a minimum 2 ft by 2 ft by 1/2 in. thick, installed in a vertical orientation.

For enhanced performance in shallow soils, provide a ground dissipation plate design per paragraph 4.4.4.3 or equivalent. Provide sacrificial anodes in addition to these standard ground plates.

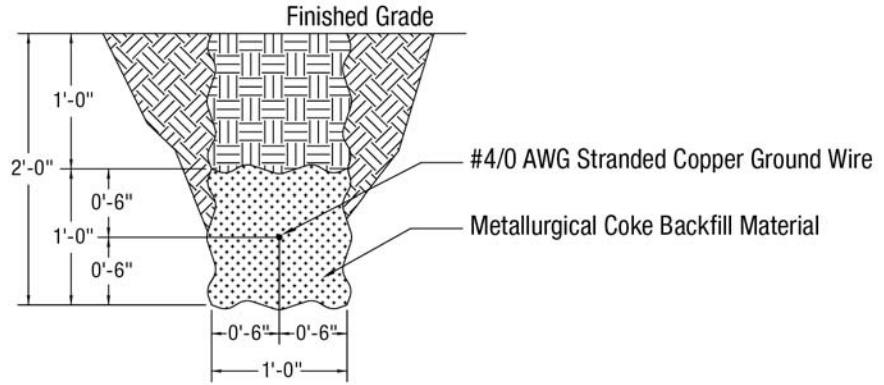

**Figure 5. Grounding Trench Detail**

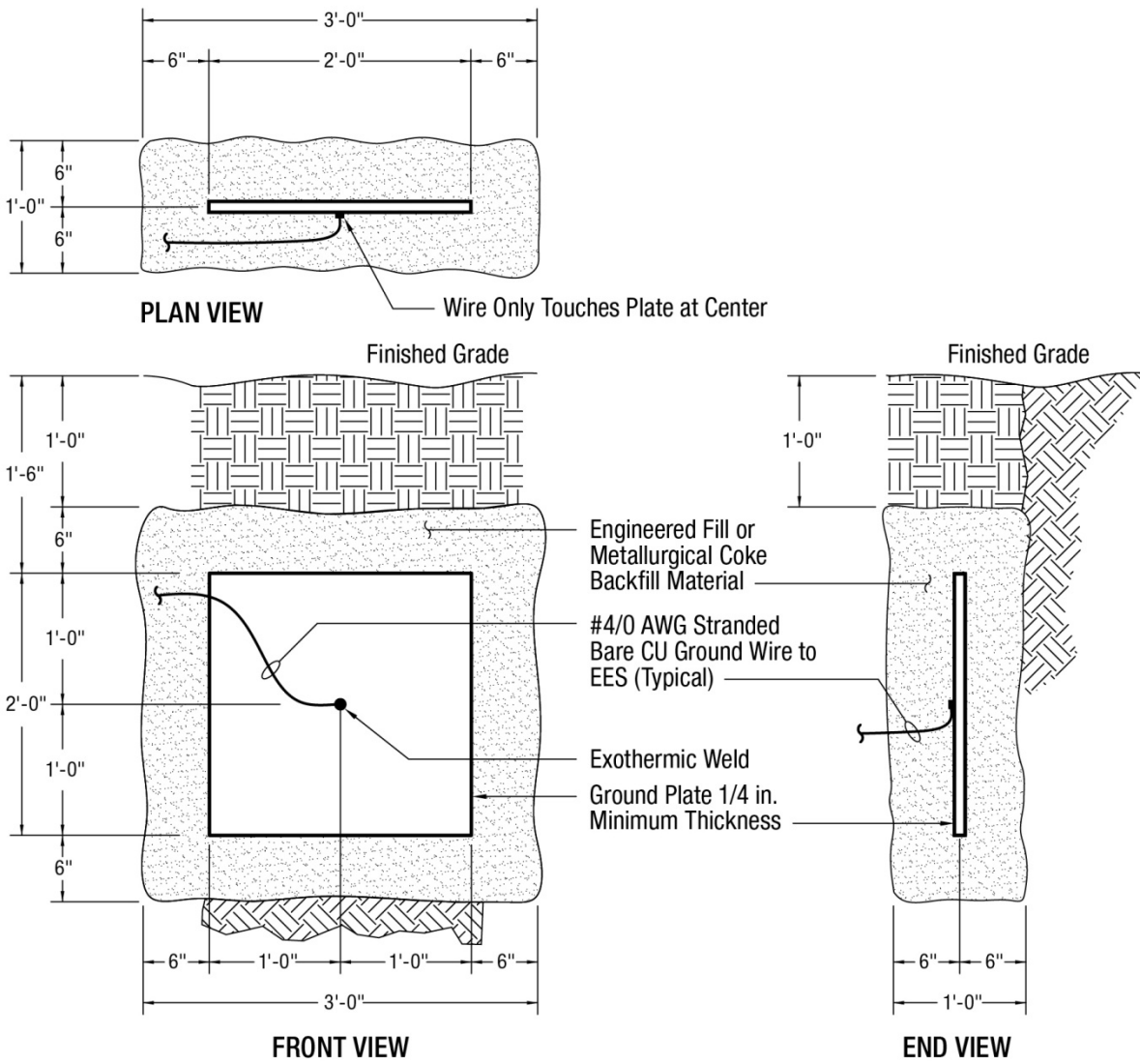

**Figure 6. Ground Dissipation Plate Detail**

## 4.5 National Electric Code - Power Distribution System Grounding Compliance

### 4.5.1 General

The facility electrical grounding shall exceed requirements of NEC Article 250 as specified herein.

### 4.5.2 Grounding Electrode Conductors (GEC)

Grounding electrode conductors (GEC) shall conform to the following:

- a. GEC and Jumper Size. The GEC and system bonding jumper shall be sized in accordance with NEC Article 250.
- b. GEC Termination and System Bonding Conductor. The GEC connection shall be terminated in the service disconnecting means (SDM). System bonding conductor shall be installed at the same location as the SDM.
- c. GEC Splicing and Routing through Metal Enclosures. If the GEC is spliced using a hydraulically crimped connector, the connector shall comply with paragraph 4.2.3.2. When a GEC is routed through a metal enclosure, such as conduit, the enclosure shall be bonded with the same size conductor at each end to the GEC.
- d. Separately Derived Systems. For a separately derived system, the system bonding jumper and the GEC shall be located at the first downstream system disconnecting means or overcurrent device. Connect the GEC directly to the EES, where possible, or terminate the GEC to the nearest effectively grounded structural steel member.

### 4.5.3 Equipment Grounding Conductors (EGC)

The EGC shall be a green insulated wire routed in the same raceway as the circuit phase and neutral conductors. Where power is supplied to electronic equipment through a cable and connector, the connector shall contain a pin to continue the EGC to the equipment chassis. Conduit or cable shields shall not be used as the sole EGC. Installation shall be in accordance with the NEC, FAA-C-1217, and the following:

- a. Grounding Terminals in Receptacles on Multi-Outlet Assemblies. These terminals shall be hardwired to an EGC. Strips that depend on serrated or toothed fingers for grounding shall not be used.
- b. Expansion joints. Conduit expansion joints shall be UL listed expansion joint fittings.

Where power conductors and the EGC are to be extended to a second building or structure, the neutral to ground bond of the power system shall originate at the first building electrical service entrance point. The grounded conductor shall not be connected to the EGC or EES at the second building or structure.

### 4.5.4 Grounding Bushings for Conduit Raceways

A grounding bushing is a conduit fitting that contains a lug for connecting a bonding jumper from the conduit bushing to the equipment ground bus or metal enclosure. This bonding jumper supplements the existing mechanical connection using locknuts and therefore improves the grounding integrity of the installation. The FAA has opted to exceed the minimum NEC raceway

grounding bushing installation requirements for power and communication distribution systems that serve NAS facilities.

Provide grounding bushings for conduit raceway systems for the following conditions:

- a. IMC and RMC Conduits. A grounding bushing shall be installed on the interior threaded end of the conduit to protect conductor insulation (see Figure 7).
- b. EMT Conduits. The connectors shall have an insulated throat, smooth bell shaped end, or a grounding bushing.
- c. Communication Conduit Pathways. Provide grounding bushings where conduits enter or leave the building. Additional grounding bushings are not required for electrically continuous conduit pathways located inside the building, unless otherwise required for electronic equipment operations. Bond each conduit with a 6 AWG or larger size conductor to the nearest SRS (with the exception of the single point ground system). If there are multiple conduits in the same junction box, the conduits can be bonded to a new ground bus established within the junction box with a 6 AWG or larger size conductor connected to the SRS (with the exception of the single point ground system).

***Exception.*** *Pullboxes and junction boxes are exempt from the grounding bushing requirement unless required by NEC or equipment installation requirement.*

#### **4.5.4.1 Non-Current-Carrying Metal Equipment Enclosures**

Non-current-carrying metal equipment enclosures include electrical equipment such as switchgear, panelboards, safety disconnect switches, raceways, and cable trays. The insulating finishes shall be removed between grounding and bonding areas of mating surfaces or bonding jumper connection points. The raceway systems shall be made electrically continuous in accordance with the following:

- a. Noncontinuous Ferrous Conduit Pathways or Sleeves. Pathways used for routing conductors only shall be equipped with grounding bushings at each end of the conduit pathway. The grounding conductor shall be bonded to the bushings with a bonding jumper the same size as the grounding conductor, see Figure 7 illustrative example.
- b. Continuous Conduit Systems. Systems that terminate at electrical equipment with grounding bushings as required in 4.5.4 shall be bonded to equipment ground bus with a bonding jumper the same size as the EGC. This shall be accomplished in accordance with Figure 7.
- c. Ferrous Materials. These materials shall be used for enclosures, raceways, and cable trays when required to provide shielding from magnetic fields.
- d. Battery Supporting Racks. These racks shall be bonded either directly to the EES or to a grounded structure with a minimum 2 AWG conductor.

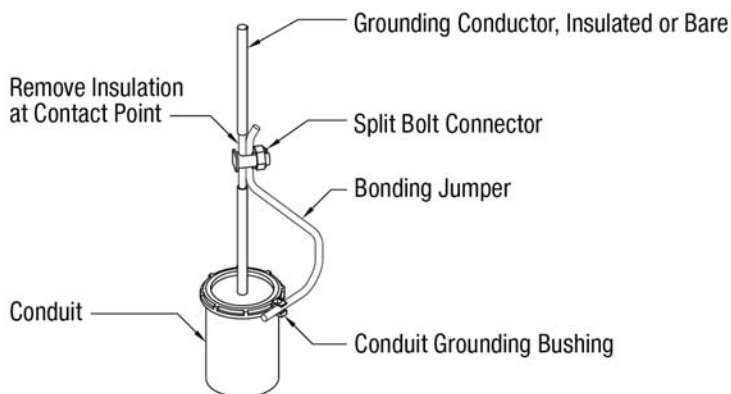

**ILLUSTRATIVE EXAMPLE: CONDUIT RACEWAY**

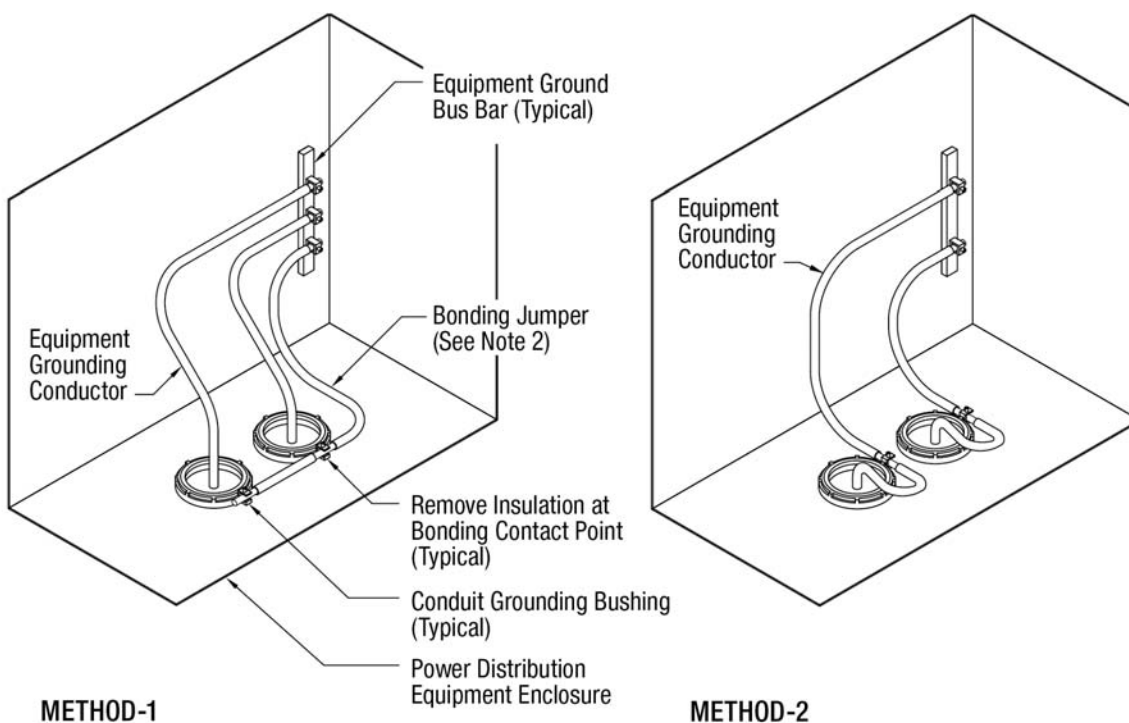

**ILLUSTRATIVE EXAMPLES: POWER DISTRIBUTION EQUIPMENT**

Notes:

1. The illustrative examples depict typical bonding concept, other engineered solutions may be possible.
2. The bonding jumper shall be sized as large as the largest EGC going through the conduits being used for grounding bushings.

**Figure 7. Bonding of Grounding Conductor to Conduit or Equipment**



#### 4.5.5 Interior Metal Piping Systems

Interior metal piping systems shall be bonded in accordance with the NEC.

Interior metal piping systems, such as mechanical and related metal piping systems located within the perimeter of SRS areas for NAS electronic equipment, shall be bonded in accordance with paragraph 4.7.3.2.

#### 4.5.6 Building Structural Steel

Bonding of building structural steel elements shall be in accordance with the following:

- a. NEC Compliance. At the electrical power service entrance and separately derived power source equipment, building structural steel shall be bonded in accordance with the NEC.
- b. Periphery of NAS Equipment Room. Main building structural steel members of columns and beams at the periphery of NAS electronic equipment rooms shall be electrically continuous. This shall be accomplished by either direct or indirect bonding of the columns and beams. Where direct bonding is not practical, indirect bonds with copper conductor shall be used with a minimum of two 2 AWG conductors per 100 ft<sup>2</sup> of steel decking, metallic wall covering, etc. These connections shall be applied via an exothermic weld or a hydraulically crimped two-hole termination. Surface coatings shall be removed in accordance with paragraph 4.2.4.1.
- c. Building Perimeter Steel. Building perimeter steel columns shall be bonded to the EES in accordance with paragraph 4.4.4.2c.

***Exception.*** *Concrete-encased steel reinforcement used in precast construction elements is exempt from the bonding requirements.*

## 4.6 Surge Protection Device (SPD) Requirements

### 4.6.1 General

SPDs shall be provided at locations where electrical power systems are susceptible to conducted power line surges. SPD equipment functional performance requirements are detailed in section 5.7. Selection of appropriate SPD depends on location and application. The SPDs and transient suppression provided at electronic equipment power line entrances shall be coordinated as required herein and paragraph 5.6.4.

### 4.6.2 SPD for Power Distribution System

SPDs shall be provided at the following locations:

- a. Service Disconnecting Means. Provide SPD on the load side of the SDM.
- b. Facility Entrance Point. Provide SPD on the load side of a facility entrance point. For example, if the facility entrance point is within a NAS electronic equipment room, the SPD is required at the first distribution panelboard that supplies the branch panelboards within the room.
- c. Transfer Switch, Switchboard, or Panelboard. Provide SPD either on the load side of an engine generator transfer switch, or on the first switchboard or distribution panelboard located downstream of the transfer switch.
- d. Panelboards Feeding Building Exterior Loads. Provide SPDs at panelboards that supply branch circuit wiring exiting the building to serve exterior equipment.
- e. Secondary Transformer. Provide SPD at separately derived power source that feeds NAS electronic equipment.

A lightning arrester shall be installed on the primary side of FAA-owned distribution transformers. Lightning arresters and SPDs shall be approved by the OPR.

#### 4.6.2.1 SPD for Facility Entrance Equipment

SPDs shall be provided at the SDM, at all facility entrance penetrations, and at feeder and branch panelboards as specified in paragraph 4.6.2.2. Additional SPDs shall be provided at the power line entrances to operational electronic equipment.

#### 4.6.2.2 SPD for Power Distribution Feeders and Panelboards

SPDs shall be installed on switchgear, panelboards, and disconnect switches providing service to NAS operational equipment or supplying exterior circuits.

Examples of exterior circuits include obstruction lights, convenience outlets, guard houses, security systems, electric gates, and feeds to other facilities.

Where feeder and branch panelboards are located close together and their panelboards do not serve exterior circuits, use the SPD location decision tree diagram, Figure 8, to determine if an SPD is required for branch panelboards. SPDs for panelboards that provide service to exterior circuits shall meet requirements of paragraphs 5.7.2.1.1, 5.7.2.1.2, and 5.7.2.1.3 for facility entrance SPDs.

SPDs shall be installed as close as possible to the panelboard they serve and in accordance with the manufacturer's instructions. A feeder or branch panelboard SPD shall be provided with an overcurrent protection device. Overcurrent protective device (OCPD) examples include a fuse or circuit breaker fitted internal to the SPD or fitted to the panelboard and dedicated to the SPD. The overcurrent device shall not increase the clamp voltage of the SPD by more than 5 percent and shall pass the surge current values listed in Table 11 up to the 40 kA level without opening. Overcurrent devices for exterior circuits shall pass all surge current values in Table 11. Overcurrent devices, both internal and external to the SPD, and SPD short circuit current ratings, shall be sized and coordinated in accordance with the NEC and be field resettable or replaceable.

#### **4.6.2.3 SPD Installation Requirements**

SPDs shall be installed as close as possible to the panelboard or equipment that is being protected. Conductors shall be made as short as possible. Connections shall be made with UL listed connectors identified for the wire size and type used.

- a. Connections. Install the maximum conductor size allowed by the SPD manufacturer, but do not exceed the incoming circuit phase and grounding conductor size permitted by the panelboard, SDM , or protected equipment. Conductors shall be color-coded in accordance with FAA-C-1217, and as short and direct as possible without loops, sharp bends, or kinks. The ground bus in the service entrance enclosure shall be bonded directly to the SPD terminal marked G or ground. The SPD enclosure shall be bonded to the SPD ground terminal.
- b. Conduit Sealing. The conduit connecting the SPD enclosure to the SDM enclosure or panelboard shall be sealed with duct seal or other UL listed nonflammable, inorganic potting material to prevent soot from entering the protected enclosure in the event of SPD failure.

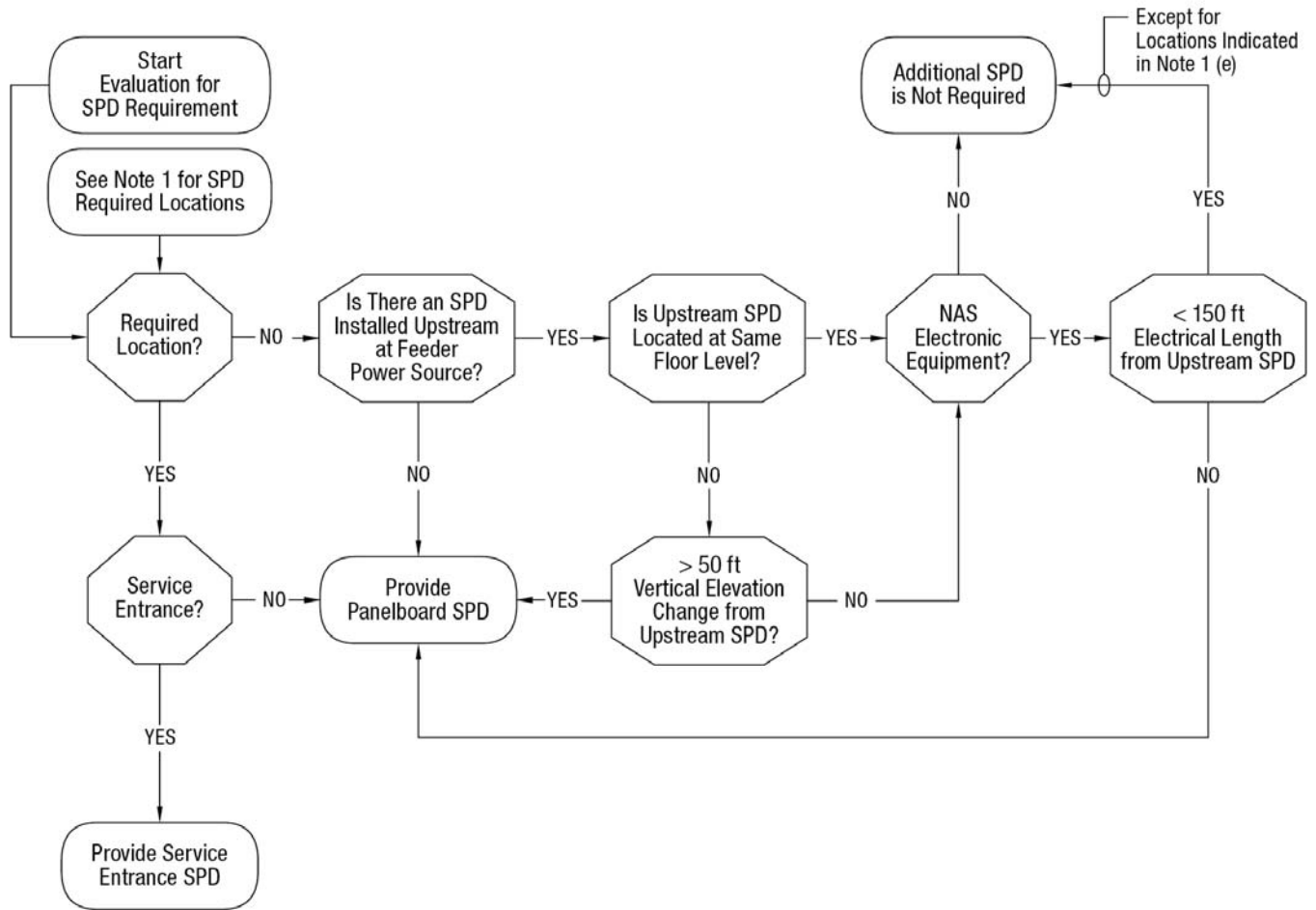

Notes:

1. Provide SPDs in accordance with paragraph 4.6.2 and for the following locations.
  - a. Power service disconnecting means (SDM).
  - b. Load side of automatic transfer switch (ATS).
  - c. Transformer, secondary of separately derived power source.
  - d. Panelboards with branch circuits that feed building exterior loads.
  - e. Power feeder that supplies the panelboards for NAS electronic equipment room. SPD is required at the first panelboard located within the room.

**Figure 8. SPD Location Diagram - Close Proximity Allowance Decision Tree**

**4.6.3 SPD for Signal, Control, and Data Line Surge Protection**

Provide SPDs at the following locations:

- a. Facility entrances,
- b. Entrances to NAS electronic equipment (see paragraph 5.6.3),
- c. Entrances to electronic equipment installed by the telecommunication service provider.

## 4.7 Grounding and Bonding for NAS Electronic Equipment Areas

### 4.7.1 General

This section describes grounding and bonding requirements for protection of NAS electronic equipment housed in designated NAS electronic equipment areas within FAA Facilities. Aspects of the grounding and bonding system include the following:

- a. NAS Facilities Main Grounding Connection. This connection requires a main and supplemental ground plate, designed in accordance with paragraph 4.7.2. See paragraph 5.2.3 for ATCT facilities special requirements.
- b. Signal Reference Structures. The SRS system requires grounding elements designed in accordance with paragraph 4.7.3.

### 4.7.2 Main and Supplemental Ground Plates

A main ground plate shall be established as a common point of connection for SRSs for the entire facility.

A supplemental ground plate shall be established at the opposite side of the facility to the main ground plate. This supplemental ground plate shall be used for a second connection of the multipoint ground system, signal reference grid, or signal reference plane to the EES. The use of multiple supplemental ground plates is permitted at large facilities.

Both the main ground plate and the supplemental ground plates shall conform to the following:

- a. Located within 50 ft of the EES.
- b. Each plate shall be connected to the EES with a 500 kcmil conductor.
- c. Supplemental ground plates and the main ground plate shall be interconnected with an insulated 4/0 AWG cable, color coded with green and orange tracer.

See Table 4 for the main and supplemental ground plate installation requirements. See Figure 9 for typical facility grounding system.

***Exception.*** For buildings of 200 ft<sup>2</sup> or less, only the main ground plate is required. Connect the main ground plate to the EES with two 4/0 AWG stranded copper conductors. One of the conductors shall be 20 percent longer than the other. All signal grounding, single point or multipoint, shall terminate on this plate. No additional ground plates are required.

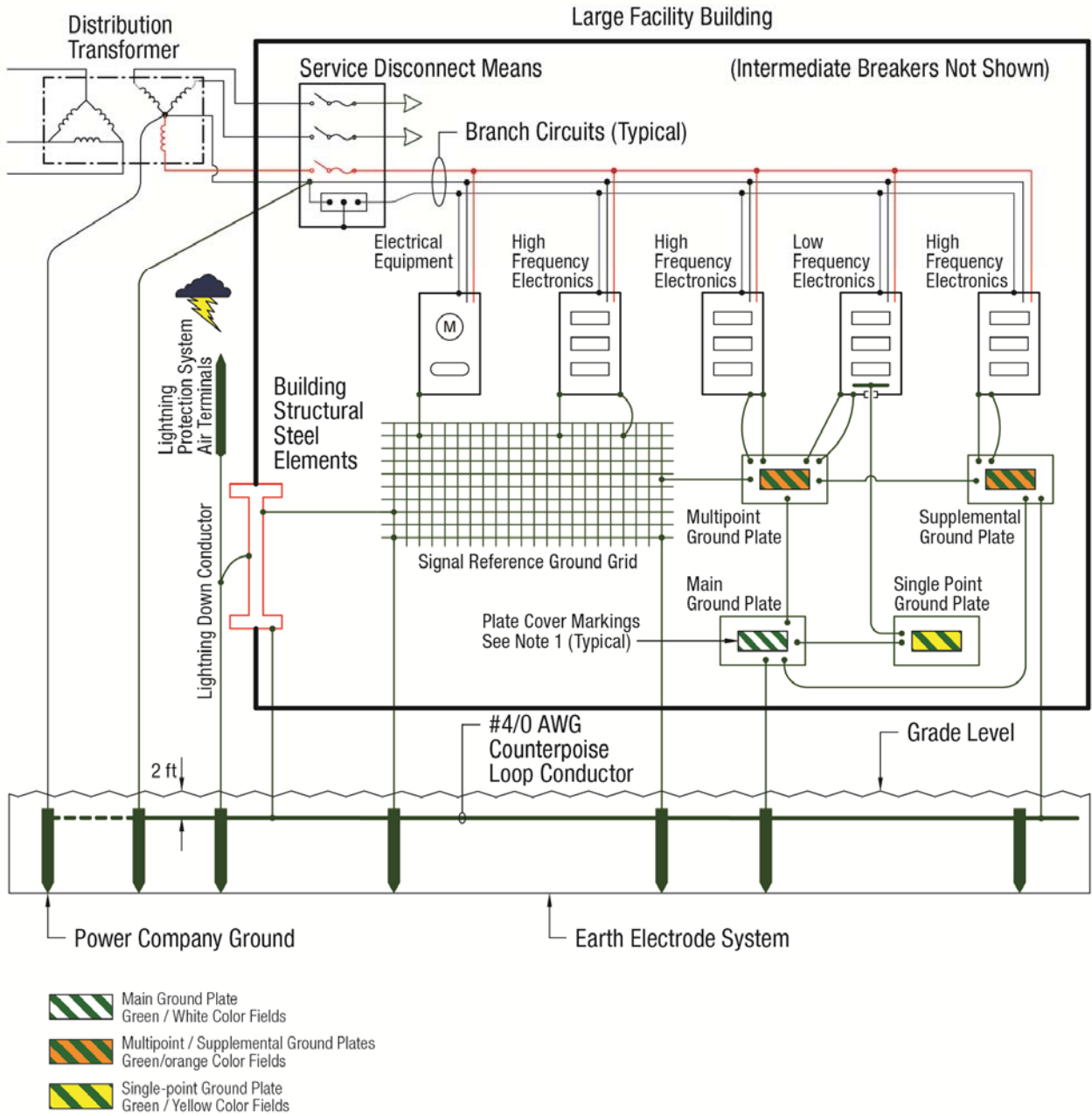

**Figure 9. Typical Facility Grounding System**

### 4.7.3 Signal Reference Structures (SRS) – Requirements

Enclosed building facilities used to house NAS electronic equipment shall be equipped with an SRS. Types of SRS include the following systems:

- a. Multipoint Ground System (MPG) constructed using conductors and ground plates.
- b. Signal Reference Ground Grid (SRGG) constructed using copper strips.
- c. Signal Reference Ground Plane (SRGP) constructed using copper sheets.
- d. Single Point Ground System (SPG) is a special grounding system defined in section 5.5. This topology shall only be installed as directed in section 5.5 and connected to the MPG, SRGG, or SRGP as directed in section 5.5, and it shall not be used as an applicable SRS as outlined in the rest of 4.7 and its sub-sections.
- e. Engineered Hybrid System is a combination of MPG, SRGG, or SRGP grounding systems.

Provide an SRS for the following areas:

- a. NAS Operations Areas. Entire room area.
- b. Other Electronic Equipment Areas. Areas containing electronic equipment supporting NAS operations. Provide for the entire room area.
- c. Other Power Conditioning Equipment Areas. Areas containing power conditioning equipment, such as site wide uninterruptible power supply (UPS), shall be bonded to the SRS system described above.

The above-referenced electronic and electrical equipment shall be bonded to the SRS in the area. SRSs located on the same floor or on different floors shall be bonded together using at least two separate paths. Multiple components of the facility SRS, but not the SPG system, shall be bonded together with a minimum of two 4/0 AWG conductors.

Design SRS systems for site-specific requirements of the facilities and equipment. SRS applications require analysis of equipment bandwidth, and equipment and SRS impedances. SRS analysis shall consider, among other parameters, operating frequencies and impedances, transmission line communication models for bonding wires, noise levels in low-frequency analog-based equipment, and the influence of high-frequency digital signal and logic equipment. All conductors and cabling of NAS electronic equipment systems operating nominally at a wavelength less than  $\lambda/20$  of the highest system frequency shall lay on or very close to the SRS. Bonding connections between the electronic equipment and SRS shall be close-coupled so that the bonding jumpers are as short as possible, and routed to the nearest SRS connection point.

The SRS shall be located in the vicinity of the electronic equipment. Signal-carrying conductors, axial lines, waveguides, and cabling interconnections between equipment shall be routed in immediate proximity to the SRS. For overhead feeds, use overhead SRS systems. For underfloor feeds in raised access floors, use underfloor SRS systems. Where equipment is fed from both overhead and underfloor feeds, use a hybrid SRS system made up of MPG, SRGG or SRGP bonded together. MPGs, SRGGs, and SRGPs may be installed on ceilings, walls, or floors.



If NAS electronic equipment is installed in non-NAS electronic equipment rooms such as administrative areas, the NAS electronic equipment shall be bonded to a nearby SRS system. If there is no nearby SRS system, then establish a new MPG based on the footprint area of the NAS electronic equipment. If the square footage of the area is small enough, then install a small MPG system in accordance with paragraph 4.7.2.

The MPG and SRS systems shall be connected to the main and supplemental ground plates with conductors sized in accordance with paragraph 4.7.3.1.3. Each connection shall be to the nearest MPG plate or SRS.

#### **4.7.3.1 Multipoint Ground System (MPG)**

The protection of electronic equipment against potential differences and static charge buildup shall be provided by interconnecting non-current-carrying metal objects to an MPG that is effectively connected to the EES. The MPG consists of a network of plates and bonding jumpers, racks, frames, cabinets, conduits, wireways, cable trays enclosing electronic conductors, structural steel members, and conductors used for interconnections. The MPG shall provide multiple low-impedance paths to the EES, between various parts of the facility, and between electronic equipment within the facility so that any point of the system has a low-impedance path to the EES. This will minimize the effects of spurious currents present in the ground system due to equipment operation or malfunction, or from lightning discharges. The MPG shall not be used in lieu of the safety ground required by the NEC or as a signal return path.

##### **4.7.3.1.1 Labeling**

The MPG shall be clearly labeled to preserve its identity as described in the following paragraphs.

###### **4.7.3.1.1.1 Conductor Identification**

MPG conductors shall be labeled in accordance with paragraph 4.7.3.1.6.

###### **4.7.3.1.1.2 Ground Plate Labeling**

Ground plates shall be installed in accordance with Table 4.

###### **4.7.3.1.2 MPG - Ground Plates and Buses**

Multipoint ground plates shall be located to facilitate the interconnection of equipment cabinets, racks, and cases within a particular area. If more than one ground plate is necessary, they shall be located throughout the facility. Ground buses may be used when distributed grounding is required along a long continuous row of electronic equipment cabinets.

See Table 4 for the multipoint ground plate installation requirements. Ground buses shall be copper material. Ground bus width and thickness shall be selected from Table 3, and shall be as long as required.

Provide a secondary conductor return path for each MPG plate or ground bus. A single-ended, radial connected plate or bus configuration is not permitted. Building structural steel shall not be used as a secondary return path for the MPG.

**4.7.3.1.3 MPG Conductors – Plate to Plate and Plate to Bus**

Conductors between plates and buses in the multipoint system shall be insulated and sized in accordance with Table 3 based on the maximum path length to the farthest point in the MPG from the EES. To determine the distance to the farthest point in the multipoint system, add the length of conductors in the multipoint system to reach the farthest plate in the system via the longest path as shown in Figure 10. Divide the sum obtained by two to obtain the maximum path length. Use this path length to determine the conductor size from Figure 10, but in no case use a conductor smaller than 4/0 AWG. These conductors shall be insulated, labeled, and color-coded in accordance with paragraph 4.7.3.1.6. In cable trays, ground conductors shall be insulated and separated as far as possible from the other conductors.

**Exception.** *In plenum spaces, where plenum-rated insulated conductors are not available, bare ground conductors are permitted.*

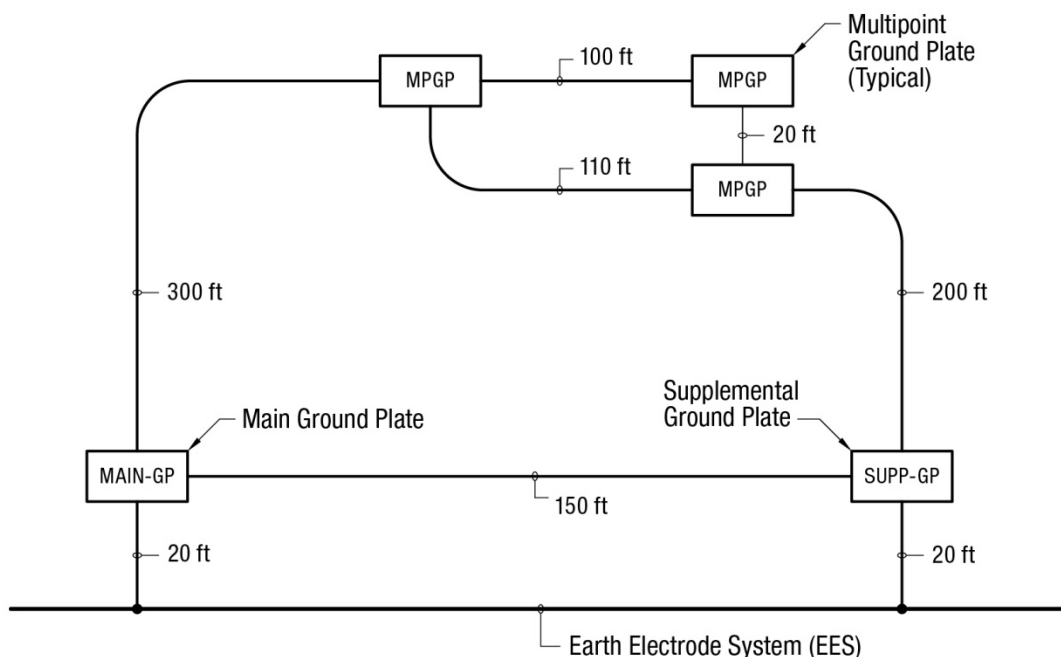

Notes:

1. Determine the longest cable path between the main and supplemental ground plate connections to the EES by adding the sum of individual cable segments along the pathway.  
 Maximum path length = 20+300+100+20+200+20 = 660 ft
2. Divide total obtained in step 1 by two.  
 $660/2 = 330$  ft
3. Determine conductor size from Table 3. Using 330 ft path length, select 750 kcmil size conductor.

**Figure 10. Multipoint Ground Conductor Size Determination**

**Table 3. Size of Electronic Multipoint Ground Interconnecting Conductors**

<b>Conductor Size (AWG or kcmil)</b>	<b>Max. Path Length (ft)</b>	<b>Bus Bar Size, See Note 2 (in.)</b>	<b>Max. Path Length (ft)</b>
750, See Note 1	375	4 x 1/4	636
600, See Note 1	300	4 x 1/8	318
500	250	3 x 1/4	476
350	175	3 x 1/8	238
300	150	2 x 1/4	318
250	125	2 x 1/8	159
4/0	105	2 x 1/16	79
3/0	84	1 x 1/4	159
2/0	66	1 x 1/8	79
1/0	53	1 x 1/16	39
1	41		
2	33		
4	21		
6	14		
8, See Note 3	9		
10, See Note 3	6		
12, See Note 3	4		

Notes:

1. Where these conductors are not available, parallel conductors are permitted, such as three 250 kcmil conductors in place of one 750 kcmil conductor, or two 300 kcmil conductors in place of one 600 kcmil conductor. Conductor sizing is based on providing a cross-sectional area of 2,000 cmil per linear ft. Bus bar sizes are chosen from available cross-sections and shall exceed the cross-sectional requirement of 2,000 cmil per linear ft.
2. Denotes an MPG designed with a continuous bus bar layout in lieu of ground plates and interconnecting conductors.
3. Conductor wire sizes 12 AWG through 8 AWG are permitted only for bond jumper connections between subassemblies and interior cabinet ground plate within the electronic equipment enclosure.

**Table 4. Ground Plate Specification Requirements**

Plate Type	Acronym	Application Requirements (see article)	Material	Configuration Notes	Identification Notes
Main	Main-GP	4.7.2	Copper	1, 2, 3, 4	5, 6
Supplemental	Supp-GP	4.7.2	Copper	1, 2, 3, 4	5, 6
Multipoint	MPGP	4.7.3.1	Copper	1, 2	5, 6
Single Point	SPGP	5.5.4	Copper	1, 2	5, 6
Notes:					
1.	<u>Plate Dimensions.</u> Ground plate dimensions shall be at least 4 in. wide and 1/4 in. thick. Provide adequate length to accommodate number of bond connections plus at least two spare positions.				
2.	<u>Conductor Terminations at Ground Plates.</u> Provide either UL listed hydraulically crimped 2-bolt-hole style terminal lugs or exothermic welds for conductor terminations.				
3.	<u>Conductor Terminations at the EES.</u> The connections from ground plates to the EES shall be made with exothermic welds at the EES. The connections shall be as follows: a. <u>Conductor between Main-GP and EES.</u> Provide at least one 500 kcmil conductor. The Main-GP location shall be chosen to minimize conductor length, but shall not be more than 50 ft from the EES. b. <u>Conductor between Supp-GP and EES.</u> Provide at least one 500 kcmil conductor. The Supp-GP location shall be chosen to minimize conductor length, but shall not be more than 50 ft from the EES. The conductor length from Supp-GP to the EES shall be 30 percent longer or shorter than the conductor between the Main-GP and the EES.				
4.	<u>Interconnection of Main-GP and Supp-GP.</u> Provide a 4/0 AWG bonding conductor connected between the Main-GP and Supp-GP.				
5.	<u>Ground Plate Covers.</u> Provide clear plastic covers with a permanently attached label or metal nameplate. The nameplate text shall be color black with 3/8-in. high letters and Arial font. The cover shall be identified with color-coded overlay markings configured by system type. The nameplate caption and cover identification shall be as follows: a. <u>Main-GP.</u> Provide label caption, “MAIN GROUND PLATE” and cover markings with clear background and green slashed marking tags around the caption. b. <u>Supp-GP.</u> Provide label caption, “SUPPLEMENTAL GROUND PLATE” and cover markings with clear background and green slashed marking tags around the caption. c. <u>MPGP.</u> Provide label caption, “MULTIPOINT GROUND PLATE” and cover markings with green background and bright orange slashed marking tags around the caption. d. <u>SPGP.</u> Provide label caption, “SINGLE POINT GROUND PLATE” and cover markings with green background and bright yellow slashed marking tags around the caption.				
6.	<u>Conductor Identification Requirements.</u> See Table 5.				

#### 4.7.3.1.4 MPG Conductors - Plate and Bus to Equipment

Conductors from plates and buses in the multipoint system to equipment chassis shall be sized in accordance with Table 3 based on the maximum path length from the plate or bus to the equipment. These conductors shall be insulated, labeled, and color-coded in accordance with paragraph 4.7.3.1.6. In cable trays, ground conductors shall be separated as far as possible from the other conductors. In wireways, ground conductors shall be visible by opening any cover.

Provide grounding connections between the electronic enclosure and the MPG system in accordance with following:

- a. Bonding Connections. Bonding connections shall prevent resonant impedances at equipment operating frequencies. Provide two short low-impedance bonding jumper between the MPG and two corners of the equipment. These bonding jumpers shall be connected as far apart as possible on the equipment (ideally on opposite corners) to reduce mutual inductance, and they shall have few bends or sags. The two bonding connections shall be of unequal length (one of the connections shall be 20 percent longer or shorter than the other) so that if one strap undergoes resonance, by limiting current flow, the other strap will not. Any bend radius in the bonding conductors shall be a minimum of 8 in.
- b. Bonding Connectors. Provide bonding conductors size in accordance with Table 3 at MPG system connections.
- c. Bonding Connection Length. Bonding connections to the SRS should be as short as possible.

See Figure 11 for typical electronic equipment grounding illustrations.

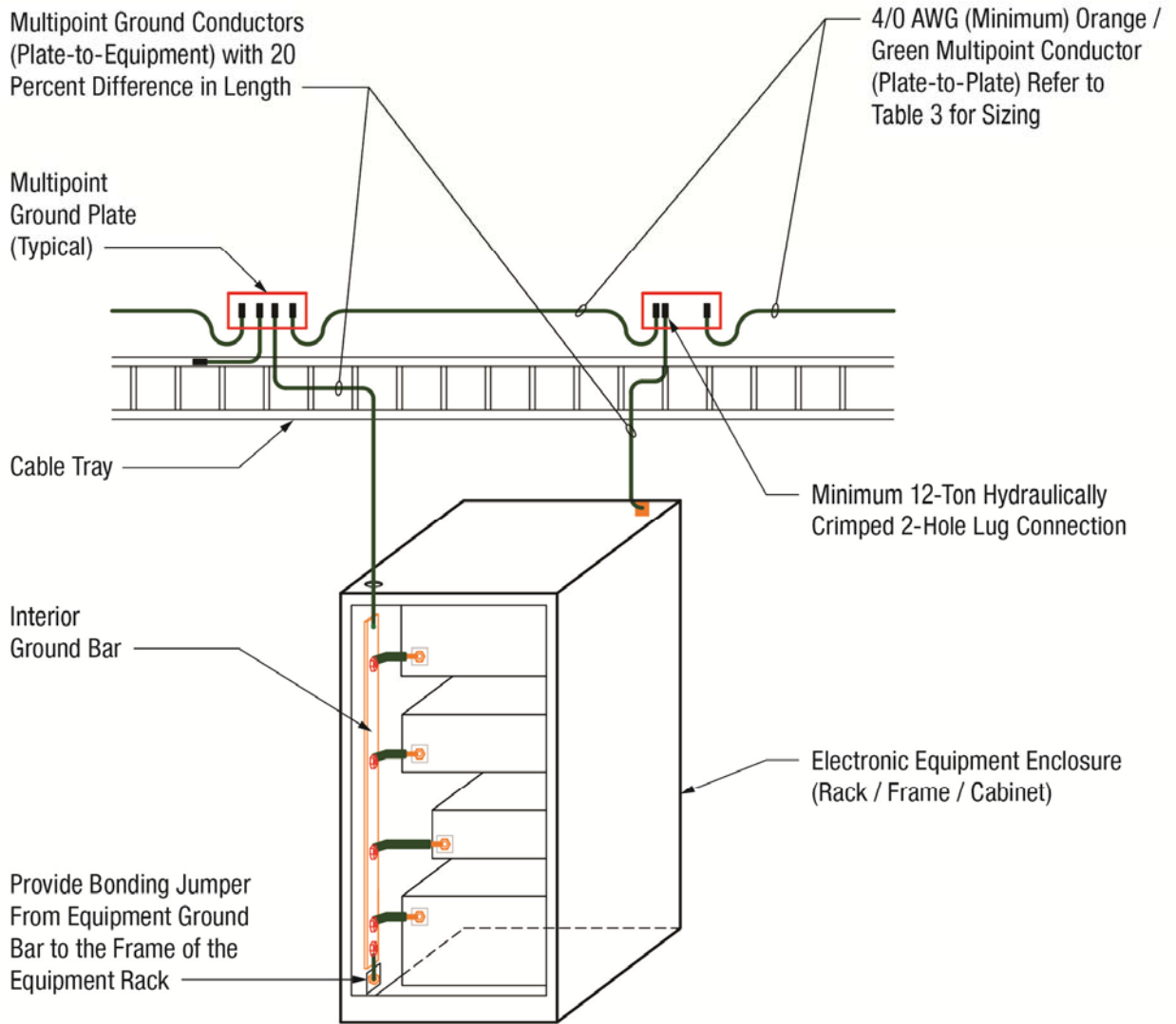

**ILLUSTRATIVE EXAMPLE:**

Notes:

1. If MPG conductors are mounted on the side or face of the cable tray, provide cable support at intervals of at least 3 ft. MPG conductor support is not required if the cables are laying on the cable tray system.
2. Paint shall be removed from the bonding surfaces before making grounding connections to the equipment enclosure. The bonding surfaces do not require paint sealing treatment if the connection is made inside an environmentally controlled room.

**Figure 11. Electronic Equipment Grounding**

**4.7.3.1.5 Grounding Conductor Protection**

Provide protection for MPG conductors subject to physical damage by use of conduit, floor trenches, routing behind permanent structural members, or other approved means. If grounding conductor is routed through metal conduit, the conduit shall be bonded to the conductor at each end.

**4.7.3.1.6 Grounding Conductor Labeling**

Provide conductor and pathway identification labeling where cables pass between areas physically separated by walls. Labeling is not required for cables that originate and terminate in the same room, such as a room without wall partitions.

**Table 5. Grounding Conductor Insulation Color Codes**

<b>Conductor Insulation - Color Identification</b>	<b>Use</b>
Green with red and yellow tracers	Isolated grounds
Green with yellow tracer	Single point ground
Green with orange tracer	Multipoint ground
Green with red tracer	High-Transient ground
<u>Notes:</u>	
1. Some commercial off-the-shelf (COTS) equipment uses green with yellow tracer as the color identification for the EGC. These conductors are permitted.	
2. Conductor labeling material type and format specification shall be in accordance with FAA-C-1217.	

**4.7.3.2 Signal Reference Ground Grid (SRGG)**

When required, the SRGG shall be provided for raised access floor systems and/or ceiling systems in NAS electronic equipment rooms or areas serving NAS electronic equipment.

The SRGG shall be configured in accordance with the following:

- a. Configuration. SRGG shall consist of a grid of 2-in. wide copper strips, 26 gauge or thicker, placed on a 2x2-ft square grid and welded at each grid intersection.
- b. Installation Location. SRGG shall be installed below a raised access floor system, below a ceiling or above a suspended ceiling system, or both. The SRGG perimeter shall extend to within 6-in. from the room perimeter or the perimeter of electronic equipment area served.
- c. Perimeter Conductor. A minimum 4/0 AWG bare copper conductor loop shall be routed around the SRGG and located within 6 in. from the SRGG perimeter. The SRGG perimeter shall be bonded to the perimeter loop conductor at every grid intersection with a 4 AWG bare copper conductor.
- d. Bonding to EES. The perimeter loop conductor shall be bonded to the EES with a minimum of four 4/0 AWG conductors spaced as widely apart as possible.

- e. Bonding to Building Steel. Building structural steel located within 6 ft of the SRGG perimeter loop conductor shall be bonded to the loop conductor with minimum 4/0 AWG conductor. Building structural steel located within the perimeter of the SRGG shall be bonded to the SRGG with a minimum 4 AWG conductor.
- f. Bonding to Floor and Ceiling Systems. The SRGG shall be bonded to the raised access floor system or the ceiling metalwork at intervals not less than 6 ft using minimum 4 AWG bare copper conductors.
- g. Bonding of Multiple SRGGs. Floor and ceiling portions of a SRGG in the served area shall be bonded together with a minimum of four sets of 4/0 AWG conductors spaced as wide apart as possible.
- h. Bonding of Raceways and Metal Objects. Conduits, wireways, pipes, cable trays, or other metallic elements that penetrate the SRGG area shall be bonded to the SRGG where they enter the area and every 25 ft for their entire length within the area. Conduits, wireways, pipes, cable trays, and other metallic elements within 6 ft of the grid shall be bonded to the SRGG. These bonds shall be minimum 4 AWG bare copper conductors.

#### **4.7.3.2.1 SRGG to Equipment**

Provide bonding straps 1 in. wide and at least 26 gauge solid copper at SRPG or SRGG connections.

#### **4.7.3.3 Signal Reference Ground Plane (SRGP) - Special Conditions**

SRGP is a continuous signal reference ground plane constructed of 24 gauge minimum thickness copper sheets. SRGP shall be provided when required by the electronic equipment vendor. SRGP designs shall be approved by the OPR.

#### **4.7.4 Bonding of Electrical Systems in NAS Electronic Equipment Areas**

Raceways/conduits, wireways, and electrical distribution equipment shall be bonded to the SRS. Metal framing channel systems used to support conduit/raceway or other equipment are expected to be installed to achieve electrical continuity, and are not required to have additional bonding jumpers between individual assembly components.

##### **4.7.4.1 Conduit Raceways**

Every component of metallic conduit runs such as individual sections, couplings, line fittings, pull boxes, junction boxes, and outlet boxes shall be made electrically continuous and bonded, either directly or indirectly, to the SRS or facility steel at intervals not exceeding 25 ft.

If otherwise not indirectly or directly bonded, bond conduits using a minimum 6 AWG bonding conductor. Conduit raceways that are less than 1.5 in. trade size or less than 10 ft in length are exempt from the bonding requirement.

##### **4.7.4.2 Cable Trays and Wireways**

If not indirectly or directly bonded, bond individual sections of metallic cable tray and wireway systems together with a minimum 6 AWG insulated copper conductor. Bonds shall be in accordance with section 4.2.



Bonding jumpers between individual sections are not required when all of the following conditions are met:

- a. The cable tray or wireway systems are electrically continuous,
- b. The systems are UL classified, suitable for use as an EGC,
- c. The systems are installed in accordance with manufacturer recommendations.

Where installed in electronic areas, cable trays and wireways shall be bonded to the SRS within 2 ft of each end of the run and at intervals not exceeding 50 ft. The minimum size bonding conductor for connection of a cable tray and wireway to the SRS shall be 2 AWG copper conductor.

## 4.8 Shielding Requirements

### 4.8.1 General

The facility design and construction shall include both protective shields to attenuate radiated signals, and separation of equipment and conductors to minimize interference coupling. The equipment design shall incorporate component compartments and overall shields as necessary to meet the electromagnetic susceptibility and emission requirements of MIL-STD-461 as required by NAS-SS-1000 and FAA-G-2100. In addition, the design shall provide personnel safety protection shielding.

### 4.8.2 Facility Shielding

Shielding of facility buildings, shelters, and equipment spaces shall be provided when other facility or environmental sources of radiation are of sufficient magnitude to degrade the operation and performance of electronic equipment or systems.

### 4.8.3 Shielding for Conductors and Cabling

Conductor and cable shielding shall comply with the following:

#### 4.8.3.1 Cables and Signal Lines

Cables consisting of multiple twisted pairs shall have individual shields for each twisted pair. The shields shall be isolated from each other. Cables with an overall shield shall have the shield insulated and isolated from individual shields.

***Exception.*** *Structured cabling for computer and telephone networks, such as Ethernet over balanced-line twisted pair with differential signaling design for noise rejection, are permitted to be used without individual shields for each twisted pair.*

#### 4.8.3.2 Cables - Termination of Individual Shields

Shields of pairs of conductors, line shields, and the shield of cables containing unshielded conductors shall be terminated in accordance with the following:

- a. Shield Terminations. Shields shall be terminated to ensure correct equipment operation.

- b. Shield Termination Lengths. Shield terminations shall consist of minimum length pigtails between the shield and the connection to the bonding halo or ferrule ring and between the halo or ferrule ring and the shield pin on the connector. The unshielded length of a signal line shall not exceed 1 in. with not more than 1/2 in. of exposed length as the desired goal.
- c. Shield Isolations. Shields, individually and collectively, shall be isolated from overall shields of cable bundles and from electronic equipment cases, racks, cabinets, junction boxes, conduit, cable trays, and elements of the MPG. Except for one interconnection, individual shields shall be isolated from each other. This isolation shall be maintained in junction boxes, patch panels, and distribution boxes throughout the cable run. When a signal line is interrupted such as in a junction box, the shield shall be carried through. The length of unshielded conductors shall not exceed 1 in. To meet this requirement, the length of shield pigtail longer than 1 in. shall be allowed but shall be the minimum required.
- d. Circuits and Chassis. Circuits and chassis shall be designed to minimize the distance from the connector or terminal strip to the point of attachment of the shield grounding conductor to the electronic signal reference. The size of the wire used to extend the shield to the circuit reference shall be as large as possible but not less than 16 AWG or the maximum wire size that will fit the connector pin. A common shield ground wire shall not be used for input and output signals, high and low level signals, signal lines, electronic signal lines, control lines, and power conductors.
- e. Extensions. Extension of shields through the connector or past the terminal strip to individual circuits or chassis is permitted if required to minimize unwanted coupling inside the electronic equipment. Where extensions of this type are necessary, overall cable or bundle shields shall be grounded in accordance with paragraph 4.8.3.3.

#### **4.8.3.3 Cables - Termination of Overall Shields**

Cables that have an overall shield over individually shielded pairs shall have the overall shield grounded at each end unless otherwise required by the equipment. Grounding through an SPD is permissible if grounding both ends of the conductors degrades system performance. If present, the drain wire shall be grounded in the same manner as the shield.

- a. Cable Shields. Cable shields terminated to connectors shall be bonded to the connector shell as shown in Figure 12 (a) or (b). The shield shall be carefully cleaned to remove dirt, moisture, and corrosion products. The connector securing clamp shall be tightened to ensure that a low-resistance bond to the connector shell is achieved along the entire circumference of the cable shield. The bond shall be protected against corrosion in accordance with paragraph 4.2.4.3. The panel-mounted part of the connector shall be bonded to the mounting surface in accordance with paragraph 5.6.6.2.
- b. Interruption of Continuity. Where the cable shield continuity is interrupted, such as in a junction box, the shield shall be extended through and grounded at the box. The length of unshielded cable conductors shall not exceed 1 in. Where dictated by constructability constraints, shield pigtails may be longer than 1 in., but shall be as short as possible.

- c. Cables Bonded to Penetrated Surfaces. Cables that penetrate walls or panels of cases or enclosures without the use of connectors shall have their shields bonded to the penetrated surface in the manner shown in Figure 12 (c). Overall shields shall be terminated at the outer surface of cases to the maximum extent possible.
- d. Overall Shield Grounding. Grounding of overall shields to terminal strips shall be as shown in Figure 13.

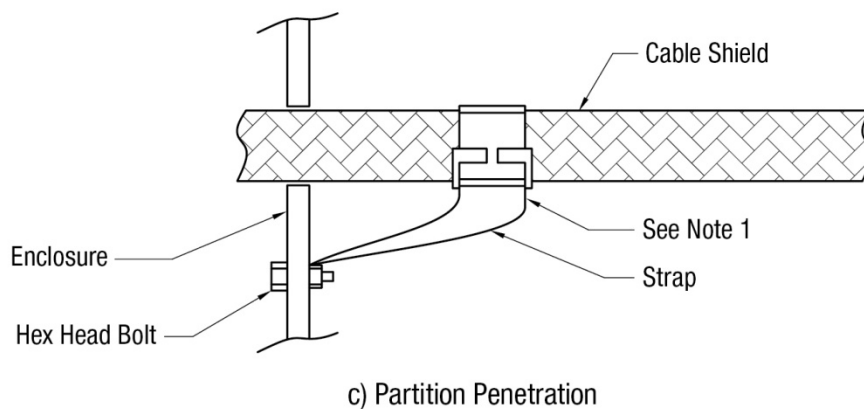
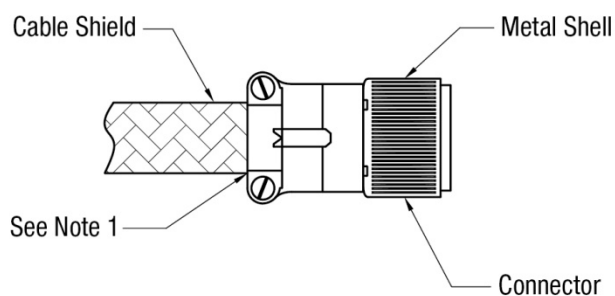
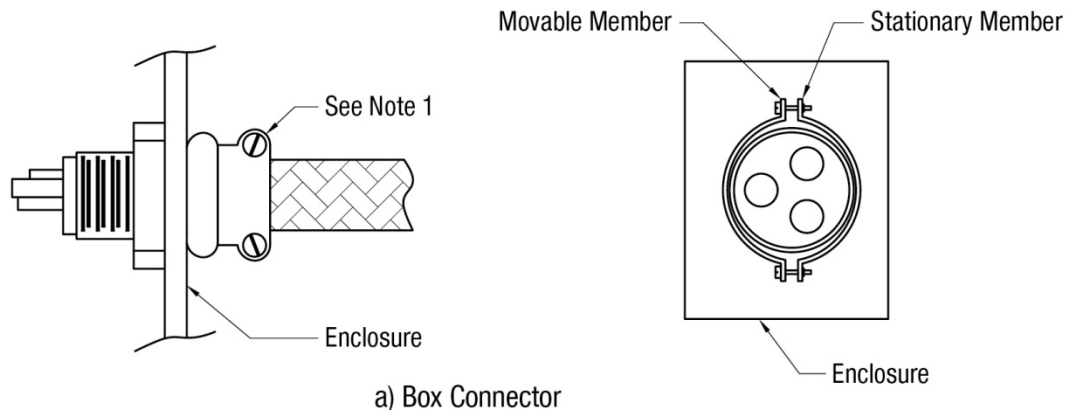

Note:

1. Ensure that cable shield is clean and that securing clamp is tightened to provide a suitable ground.

**Figure 12. Grounding of Overall Cable Shields to Connectors and Penetrating Walls**

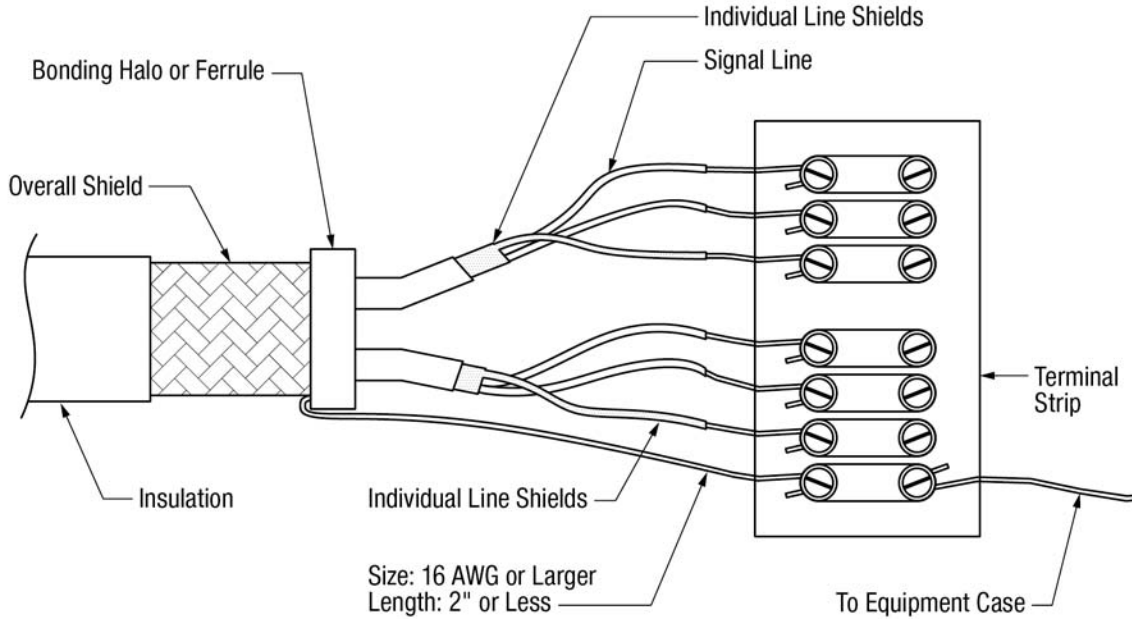

**Figure 13. Grounding of Overall Cable Shield to Terminal Strip**

**4.8.4 Electromagnetic Environment Control**

Shielding shall be integrated with other interference control measures such as filtering, wire routing, cable and circuit layout, signal processing, spectrum control, and frequency assignment to achieve the highest operational reliability of the equipment. Implementation procedures necessary to achieve the required filtering and shielding shall be detailed in the control plan described in 5.9.2 to include material requirements, shield configurations, placement and installation limitations, gasket utilization, filter integration, aperture control, bonding and grounding requirements, and wire routing and circuit layout constraints.

**4.8.4.1 Space Separation**

The design and layout of facilities shall physically separate electronic equipment and conductors that produce interference from other equipment and conductors that are susceptible to interference. The minimum separation distance between power and signal cables shall be in accordance with Table 6.

**4.8.4.2 Wire and Cable Routing**

The routing and layout of wires, conductors, and cables shall be performed in a manner that does not jeopardize the integrity of the equipment shield. Signals with power level differences of greater than 20 dB shall be routed as far apart as possible. Alternating current power conductors and control lines shall be routed away from sensitive digital or other susceptible circuits. Shielded cables shall be used where required to prevent emissions and/or to provide shielding. Cable shields shall be grounded in accordance with the requirements of paragraphs 4.8.3.2 and 4.8.3.3.

**Table 6. Minimum Separation Distance between Signal and Power Conductors**

Condition	Circuit Power Level		
	< 2 kVA	2-5 kVA	> 5 kVA
Unshielded power lines or electrical equipment in proximity to signal conductors in open cable tray or nonmetal raceway.	5 in.	12 in.	24 in.
Unshielded power lines or electrical equipment in proximity to signal conductors in a grounded metal raceway.	2.5 in.	6 in.	12 in.
Power lines enclosed in a metal raceway (or equivalent shielding) in proximity to signal conductors in a metal raceway.	-	3 in.	6 in.

**4.8.4.3 Bonding and Grounding of Compartment Shields**

All shields shall be grounded. Bonding shall be in accordance with section 4.2.

**4.9 Electrostatic Discharge (ESD) Requirements**

**4.9.1 General**

Modern electronic and electronically controlled electrical equipment are susceptible to damage from ESD. The requirements of this section are intended to reduce the frequency and minimize the effects of ESD events. Electronic circuitry that contains miniaturized or solid-state components shall be considered ESD susceptible.

**4.9.2 Requirements**

NAS electrical and electronic equipment, subassemblies, and components subject to damage from exposure to electrostatic fields or ESD shall be protected in accordance with section 5.8. ESD controlled areas shall be provided for operations, storage, repair, and maintenance spaces used for electrical and electronic equipment or subassemblies that are subject to damage from static electricity or ESD.

This Page Intentionally Left Blank

## **5 DETAILED REQUIREMENTS**

### **5.1 Introduction**

This chapter describes detailed performance requirements, which are specific to FAA facility applications, organized by facility special conditions and equipment as follows:

- a. Airport Traffic Control Tower (ATCT) Facilities
- b. Lightning Protection System – Special Conditions
- c. Facility Transient Protection – Special Conditions
- d. Single Point Ground System (SPG) – Special Conditions
- e. NAS Electronic Equipment – Interface and Procurement Requirements
- f. Surge Protection Device (SPD) – Procurement Requirements
- g. Electrostatic Discharge (ESD) Equipment – Interface and Specification Requirements
- h. Electromagnetic Compatibility Requirements



## 5.2 Airport Traffic Control Tower (ATCT) Facilities

Figure 14 depicts the elemental relationship of areas located at the top of a typical ATCT. Operation of NAS electronic equipment areas located in the cab, junction, and subjunction levels present a unique set of challenges for implementation of lightning and transient protection. NAS electronic equipment areas are spaces where the equipment is physically located or associated passageways that distribute utilities within the tower. Power and telecommunication distribution systems (NAS supporting utilities) either originate from the base of the tower or an attached base building.

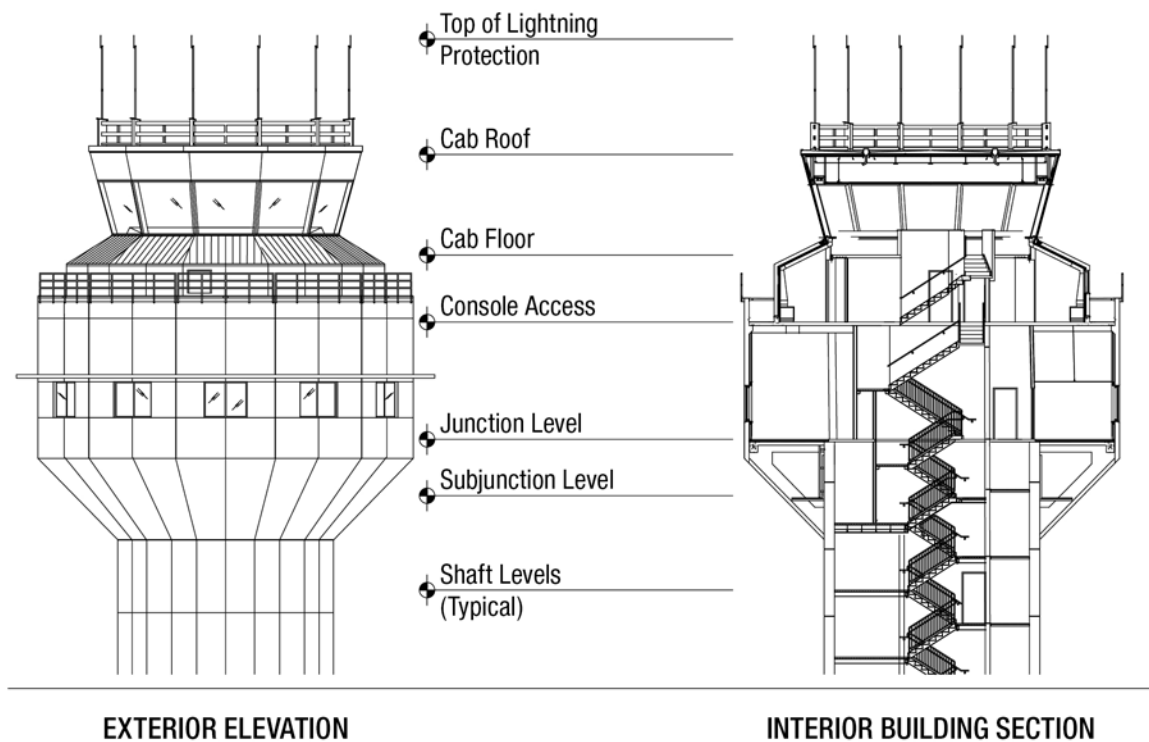

**Figure 14. Airport Traffic Control Tower – Typical Floor Levels**

### 5.2.1 General

During lightning strikes, there is a potential difference between the reference voltage at the top of the tower and the base of the tower. It is therefore necessary to reference all systems at the top of the tower to each other and treat this area as a separate facility. The NAS electronic equipment and associated supporting utility distribution system are subject to large electromagnetic fields during a lightning strike. For this reason, special techniques are required to provide an environment that minimizes the damaging effects of lightning. ATCT systems requiring special consideration include:

- a. Lightning and Transient Protection
- b. Main Ground Connections
- c. Power Distribution System
- d. NAS Electronic Equipment Areas

## 5.2.2 Lightning Protection System

Provide lightning protection in accordance with section 4.3, and this section.

### 5.2.2.1 Common Bonding of Grounded Systems

The lightning protection, electrical, electromechanical, electronic systems, and building structural steel shall be bonded together for safety.

### 5.2.2.2 Potential Equalization Loop

Provide a continuous potential equalization loop conductor at the following locations:

- a. Roof or Roof Parapet. Install a loop conductor within 24 in. of the periphery of the structure. Interconnect air terminals and down conductors to the equalization loop. Any secondary roof area or parts of the structure that extends beyond the upper most roof zone of protection scheme shall be provided with additional air terminals in accordance with NFPA 780.
- b. Exterior Platforms, Catwalks, and Personnel Access Areas. Provide a potential equalization loop for platforms that extend beyond the ATCT building perimeter. Interconnect down conductors to the equalization loop.
- c. Tower Shaft Intermediate Floor Levels. Install a loop conductor at tower intermediate levels, evenly spaced no more than 60 ft apart, measured from the roof equalization loop. Interconnect down conductors to the equalization loop.

#### 5.2.2.2.1 Horizontal (Side Strike Protection) Air Terminals for Equalization Loop

Provide horizontal air terminals on equalization loops, in addition to the zone of protection scheme, for exterior platforms and catwalks located at the cab, cab roof, or occupied areas along the ATCT shaft. Install the horizontal air terminals positioned at building corners and along the periphery of the loop where required by the lightning protection zone of protection scheme.

***Exception.*** *Horizontal (side strike) air terminals are not required for equalization loops located at intermediate floor levels of the tower shaft within the zone of protection scheme where there are no platforms for personnel access, or electronic or electromechanical equipment.*

#### 5.2.2.2.2 Connection of Down Conductor to Equalization Loop

The connection method between the down and equalization loop conductors shall be in accordance with paragraph 4.3.5.

#### 5.2.2.3 Number of External Down Conductors for ATCT

MIL-HDBK-419A, Volume II, paragraph 1.3.2.2.2(d), provides that “buildings and structures shall add one down conductor for every 60 ft of height or fraction thereof, but horizontal spacing between down conductors need not be less than 50 ft.”

The number of down conductors shall be based on both the ATCT height and its largest horizontal perimeter dimensions. For the purposes of this document, the above referenced 50-ft dimension is the horizontal distance between down conductors along the largest projected

perimeter area. The following guidelines shall be used in determining the number and configuration of external down conductors:

- a. External Down Conductors for ATCTs. All ATCTs shall have a minimum of four down conductors. ATCTs greater than or equal to 180 ft above ground level to cab roof shall add one down conductor for every 60 ft of height or fraction thereof above 180 ft. For ATCTs greater than or equal to 180 ft, the number of down conductors may be substituted, but not less than four, by using larger sized individual conductors to achieve equivalent overall conductor cross-sectional area.

***Exception.** Existing ATCTs are exempt from the minimum number of external down conductor requirement, if less than 60 ft above ground level to the cab roof and the horizontal perimeter dimension spacing between down conductors is less than 50 ft. However, when removal of the down conductors is performed as part of a major project, such as when replacing siding of an ATCT, reinstallation shall incorporate the minimum number of down conductors as stated in this paragraph.*

- b. Building Structural Steel. Building structural steel is permitted as a substitute for only one down conductor for lightning protection. Concrete encased structural reinforcing bars or precast construction systems are not qualified for use as building structural steel. It is permissible to substitute substantial metal structural elements of buildings for regular lightning conductors where, inherently or by suitable electrical bonding, they are electrically continuous from the air terminal to the earth electrode connection. The structural elements shall have a conducting cross-sectional area, including at the structural connections, at least twice that of the lightning conductor that would otherwise be used. Lightning conductors may be installed on the interior or exterior to the building enclosure. Steel frame buildings enclosed in architectural precast concrete or masonry products shall have external air terminals and roof conductors installed and bonded directly to the structural members to keep the lightning discharge from having to penetrate the masonry shell to reach the frame members. Refer to MIL-HDBK-419A, Volume II, paragraph 1.3.2.2.2(i).

#### **5.2.2.4 Transient Surge Protection**

Provide SPDs in accordance with section 4.6 for NAS facility entrance points located at the base building/tower shaft and at the top of the shaft.

#### **5.2.3 Main Ground Connections**

A low-impedance connection shall be provided to the EES to ensure good high-frequency grounding during normal operation. Ground connections shall be established in the ATCT as a common point of connection within the facility. Provide ground plates in accordance with paragraph 4.7.2 and as specified herein.

##### **5.2.3.1 ATCT MPG Configuration – Preferred Method**

Refer to Figure 15 for MPG configuration topology and connection requirements. A main ground plate shall be established on the lowest level with electrical, electromechanical, or electronic equipment serving the ATCT cab. Grounding systems located at or above this level of the ATCT shall be connected to this main ground plate. Provide a combination of conductors, in accordance

with Table 7, and two parallel paths as indicated in Figure 15. Install each conductor path within separate chases located in the tower shaft. Conductors shall be routed continuously between ground plates without sharp bends, loops, or kinks.

Recombine risers to an MPG plate at each maintenance level of the ATCT shaft. These conductors shall be mechanically bonded to the main ground plate and the base plate. Connect base plate(s) exothermically to the EES with the same number and size of conductors used for the riser conductors in accordance with Table 7.

**5.2.3.2 ATCT MPG Configuration - Alternative Method**

Refer to Figure 16 for MPG configuration topology and connection requirements. A main ground plate shall be established on the lowest level with electrical, electromechanical, or electronic equipment serving the ATCT cab. Grounding systems located at or above this level of the ATCT shall be connected to this main ground plate. Provide a combination of conductors, in accordance with Table 7, and connect this main ground plate to a plate at the base of the ATCT. These conductors shall be routed continuously from the main ground plate to the base plate without sharp bends, loops, or kinks.

**Table 7. ATCT MPG Configuration – Parallel Conductor Complements**

Electrical Distance from EES to Farthest MPG Plate Measured in Feet, See Note 1	Two (2) Conductor (kcmil)	Three (3) Conductor (kcmil)	Four (4) Conductor (kcmil)	Five (5) Conductor (kcmil)	Six (6) Conductor (kcmil)	Number of 4/0 (AWG)
Up to 250	500	350	250	4/0	-	5
251 to 300	600	400	300	250	4/0	6
301 to 350	700	500	350	300	250	7
351 to 400	800	600	400	350	300	8
401 to 450	900	600	500	400	300	9
<u>Note:</u>						
1. Refer to Figure 15 and Figure 16 for conceptual MPG configurations.						

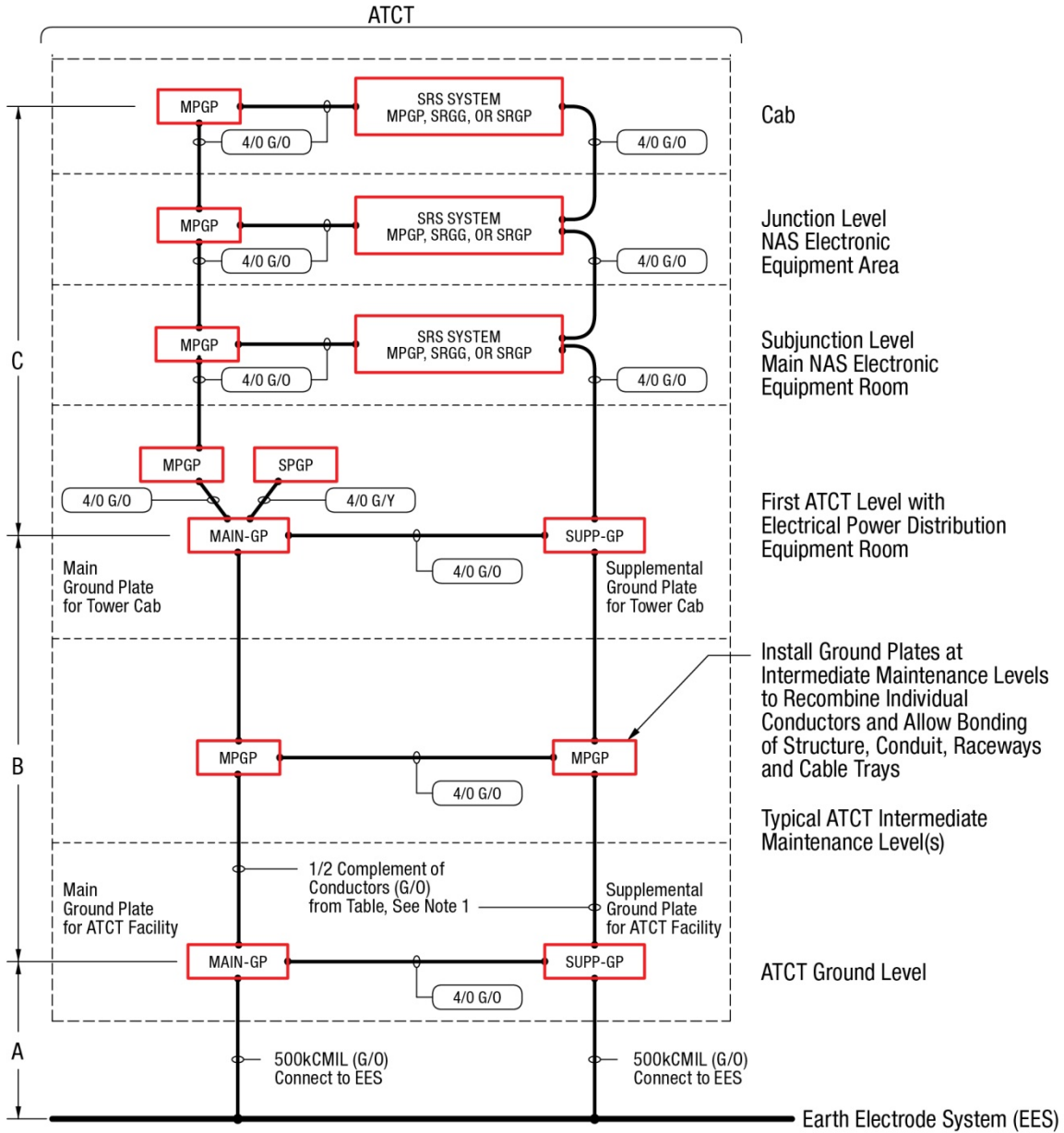

**SYMBOLS:**

- MPGP Ground Plate, Subscript Denotes:
- MAIN-GP : Main Ground Plate
- SUPP-GP : Supplemental Ground Plate
- MPGP : Multipoint Ground Plate
- SPGP : Single Point Ground Plate

- 4/0 G/O Conductor Type Designation, Insulation Color Code and Wire Size
- G/O Multipoint Ground System Conductor, Green with Orange Tracer
- G/Y Single Point Ground System Conductor, Green with Yellow Tracer
- 4/0 AWG Wire Size

Note:

1. Total height calculation (A+B+C) shall be used to determine cable size parameter indicated in Table 7.

**Figure 15. Typical Electronic Equipment Grounding Riser Diagram for ATCT (Preferred Method)**

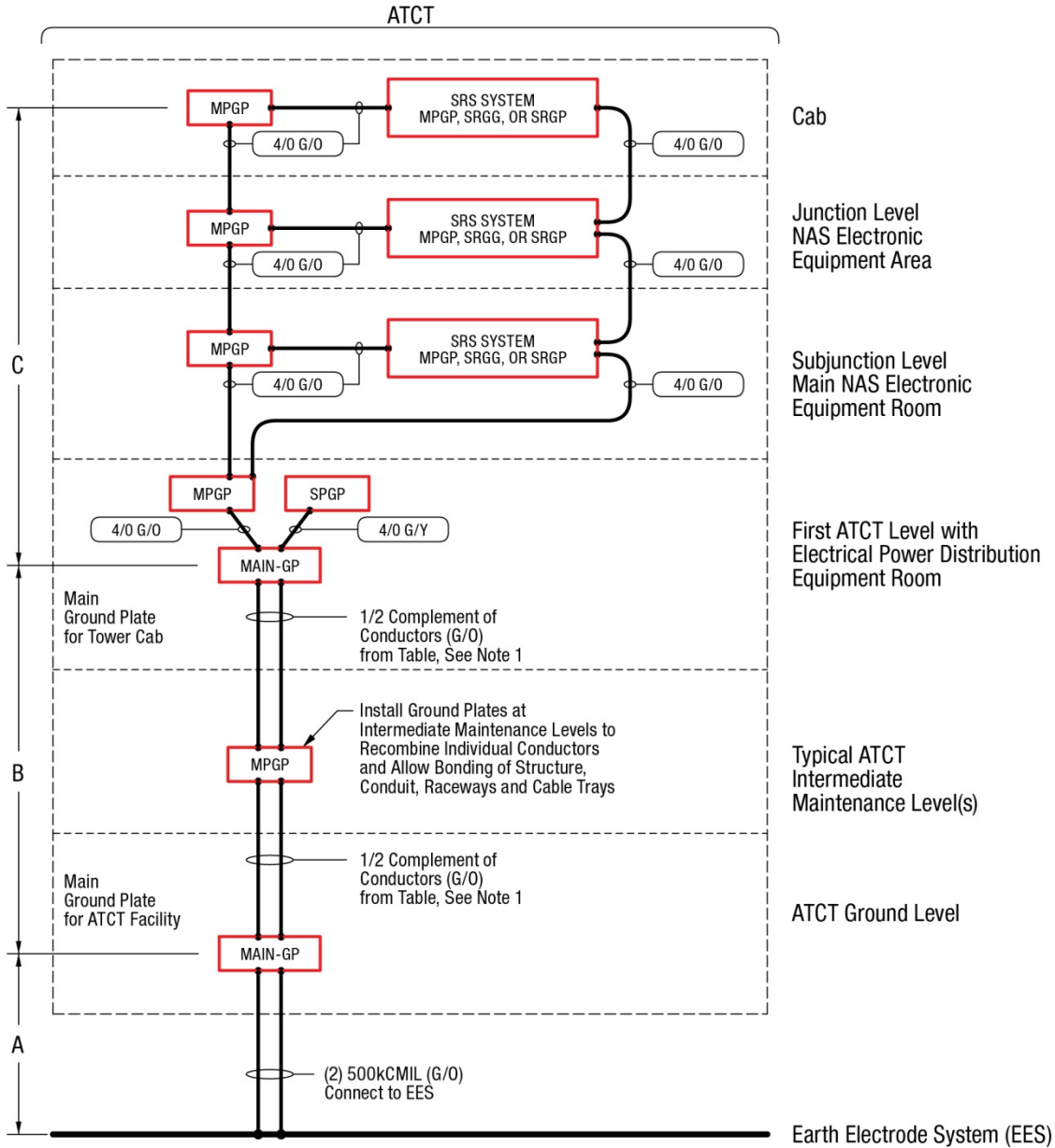

**SYMBOLS:**

**MPGP** Ground Plate, Subscript Denotes:  
 MAIN-GP : Main Ground Plate  
 MPGP : Multipoint Ground Plate  
 SPGP : Single Point Ground Plate

**4/0 G/O** Conductor Type Designation, Insulation Color Code and Wire Size  
 G/O Multipoint Ground System Conductor, Green with Orange Tracer  
 G/Y Single Point Ground System Conductor, Green with Yellow Tracer  
 4/0 AWG Wire Size

Note:

1. Total height calculation (A+B+C) shall be used to determine cable size parameter indicated in Table 7.

**Figure 16. Typical Electronic Equipment Grounding Riser Diagram for ATCT (Alternative Method)**

#### **5.2.4 Power Distribution System**

Provide power distribution for ATCT in accordance with section 4.5 and as specified herein.

- a. NAS Electronic Equipment Power Loads. Provide separately derived power sources for NAS electronic equipment loads when the ATCT height is greater than 100 ft measured to the cab floor level.
- b. Separately Derived Power Systems. The separately derived systems shall be grounded in accordance with the requirements of NEC article 250 and paragraph 4.5.2d at the first downstream disconnecting means or overcurrent device. This point of connection is mandated to facilitate the effective installation of an SPD.
- c. Surge Protection. Provide SPDs, in accordance with paragraph 4.6.2. The SPD shall be installed on the load side of the first downstream disconnecting means or overcurrent device of each separately derived system. The ground bus at the first disconnecting means or overcurrent device shall be bonded to the main ground plate established in accordance with the requirements of paragraph 5.2.3. This connection is in addition to the grounding electrode conductor requirements of NEC article 250.
- d. Bonding of Metallic Piping Systems. The interior metallic piping supply systems located at the top and bottom of the ATCT mechanical piping chase, such as water, plumbing, and mechanical piping systems, shall be bonded to the main ground plates established in accordance with the requirements paragraph 5.2.3. If interior metallic piping systems are not located near the main ground plate, bond interior piping to the nearest MGP. This connection is in addition to the bonding requirements of NEC article 250.

#### **5.2.5 NAS Electronic Equipment Areas**

Provide grounding and bonding for NAS electronic equipment in accordance with section 4.7 and paragraph 5.2.3 and as specified herein.

##### **5.2.5.1 ATCT Building Structural Steel Bonding Requirements**

Structural steel columns and beams of the ATCT shall be bonded together and to the EES in accordance with paragraph 4.5.6 and as specified herein.

The design of the ATCT shaft shall make provisions to ensure that all concrete reinforcing steel used throughout the shaft is electrically bonded together, continuously, horizontally and vertically, and to the EES.

Horizontal metal transitions, such as floors, stairs, and walkways shall be bonded to the ATCT structural steel members or concrete reinforcing steel bars at every level. Elevator support structures shall be bonded to horizontal metal transitions and to the EES. All bonding jumpers shall be a minimum 2 AWG copper conductor.

##### **5.2.5.2 Signal, Communications, Axial Cables, and Control Line Protection**

Transient protection shall be applied at each end of vertical cables routed between the equipment room located near the top of the ATCT and the associated base building. Cables between the tower cab and equipment room areas shall be protected in accordance with paragraph 4.6.3. Both

facility and equipment levels of protection shall be provided for these lines. Enclosing metallic cabling in ferrous conduit or the use of all dielectric fiber optic cable can significantly reduce the threat of lightning related damage to ATCT and base building circuits.

### **5.2.5.3 Signal Reference Structure**

An SRS shall be constructed in accordance with applicable requirements of paragraph 4.7.3, including the cab and other areas at the top of the ATCT that contain electrical, electromechanical, or electronic equipment serving the cab.

- a. SRGG Installation. The main and supplemental ground plates and building steel may be used to establish equipotential bonding for the SRGG perimeter loop conductor in lieu of the EES for facilities located at the top of the ATCT. Provide one connection between the perimeter loop conductor to the main and supplement ground plates. Provide at least two additional connections between the perimeter loop conductor and building steel.

### **5.2.5.4 Floor Coverings for Electronic Equipment and Operational Areas**

Floor coverings for cab and areas serving the cab shall either be tile or carpeting and shall be composed of static dissipative material. The floor coverings and installation shall be per the manufacturers' specifications and paragraph 5.8.9 and shall be connected to a component of the SRS, but not to the SPG system.

### **5.2.5.5 Single Point Grounding**

SPGs, if required, shall be constructed in accordance with section 5.5. SPGs and independent ground systems required by equipment manufacturers shall be bonded to the ATCT main ground plate, located at the top of the tower, in accordance with the requirements of paragraph 5.2.3. The SPG shall be constructed in a radial configuration and not form a loop.



### **5.3 Lightning Protection System – Special Conditions**

#### **5.3.1 General**

This section describes facilities or systems that require additional design considerations for installation of lightning protection systems. The following applications are addressed:

- a. Antenna Towers
- b. Antenna Protection
- c. Tower Guying
- d. Waveguide, Axial Cable, and Conduit Grounding
- e. Staircase/Ladder Protection
- f. Facilities without Buildings or Antennas
- g. Lightning Protection for Fences and Gates
- h. Lightning Protection for Photovoltaic Solar Arrays

#### **5.3.2 Antenna Towers**

##### **5.3.2.1 Number of Down Conductors for Towers**

Towers consisting of multiple, parallel segments or legs that are erected on a single pad or footing not over 9 ft<sup>2</sup> in area are considered pole type towers. Other towers shall have at least two down conductors. Large towers, such as radar towers, shall have one down conductor per leg. Down conductors on towers shall be bonded to each tower section. Down conductors shall be routed down the outside of the legs wherever possible and secured at intervals not exceeding 3 ft.

##### **5.3.2.2 Pole Type Towers**

Pole type towers shall be protected by at least one air terminal and have at least one down conductor. This is to provide a zone of protection for antennas located on the tower.

##### **5.3.2.3 Towers without Radomes**

Protection shall be provided for large radar antennas by extending structural members above the antenna and mounting the air terminal on top as shown in Figure 17 unless directed otherwise by the radar system OPR. Structural members shall be braced as necessary and shall not be used as part of the air terminal or down conductor. The air terminal shall be supported from structural framing and shall have a UL listed fitting on its base. The down conductor from the air terminal shall be connected to a perimeter conductor that forms a loop around the perimeter of the tower platform. Down conductors shall extend from the perimeter conductor to the EES. Each air terminal shall be provided with at least two paths to the ground. Conductors shall be in accordance with NFPA 780. Tower legs shall be bonded to the EES with a 4/0 AWG copper conductor exothermically welded at each end. This bonding conductor shall be either a separate conductor, or permitted to be a part of the down conductor, as described in paragraph 4.3.5.1.

#### **5.3.2.4 Radomes**

Radomes shall be located within a zone of protection established according to the 100-ft radius “rolling sphere model” described in NFPA 780. This protection is provided by air terminals mounted on the radome, or by air terminals or catenary wires mounted independently of the radome. Air terminals mounted on the radome must have two paths to the EES. A perimeter conductor shall be provided at the radar antenna deck level.

Lightning protection systems for standalone radomes shall be designed and installed in consultation with the OPR of the radar system and the OPR of this document. Paragraph 5.3.2.5 shall be used as guidance in developing lightning protection systems for these radomes.

#### **5.3.2.5 Towers with Radomes**

Lightning protection systems for towers with radomes shall be designed and installed in consultation with the OPR of the radar system and the OPR of this document.

Towers with radomes shall be protected with a minimum of one 2-ft-long air terminal at the peak and four or more air terminals equally spaced along the circumference of the radome and oriented perpendicular to the radome. The spacing and quantity of circumferential air terminals shall be adjusted if the antenna pattern is affected, but their sizing, position, and height shall establish a protection zone as specified in paragraph 5.3.2.4. Circumferential air terminals shall be interconnected with main-sized conductors.

Radial down conductors, as indicated in Figure 17, shall be connected to the air terminal on the peak. The radial down conductors shall also be connected to the perimeter conductor that forms a loop around the base of the radome. Radial down conductors on the radome shall be routed from the air terminal at the peak of the radome, in a path following the contour of the radome, to a connection with the circumferential air terminals and then to a connection with the perimeter conductor as shown in Figure 17. Deviations from the shortest possible path are permitted where nearfield radar analyses determine that interference from the conductors will degrade the performance of the radar. Bends in the radial down conductors on the radome shall maintain the largest possible radii and in no case shall be less than 12 in. One down conductor per leg shall connect the perimeter conductor at the base of the radome to the EES. Down conductors shall be bonded to each leg section. Tower legs shall be bonded to the EES with a 4/0 AWG copper conductor exothermically welded at each end. This bonding conductor can be the same conductor required in paragraph 4.3.5.1.

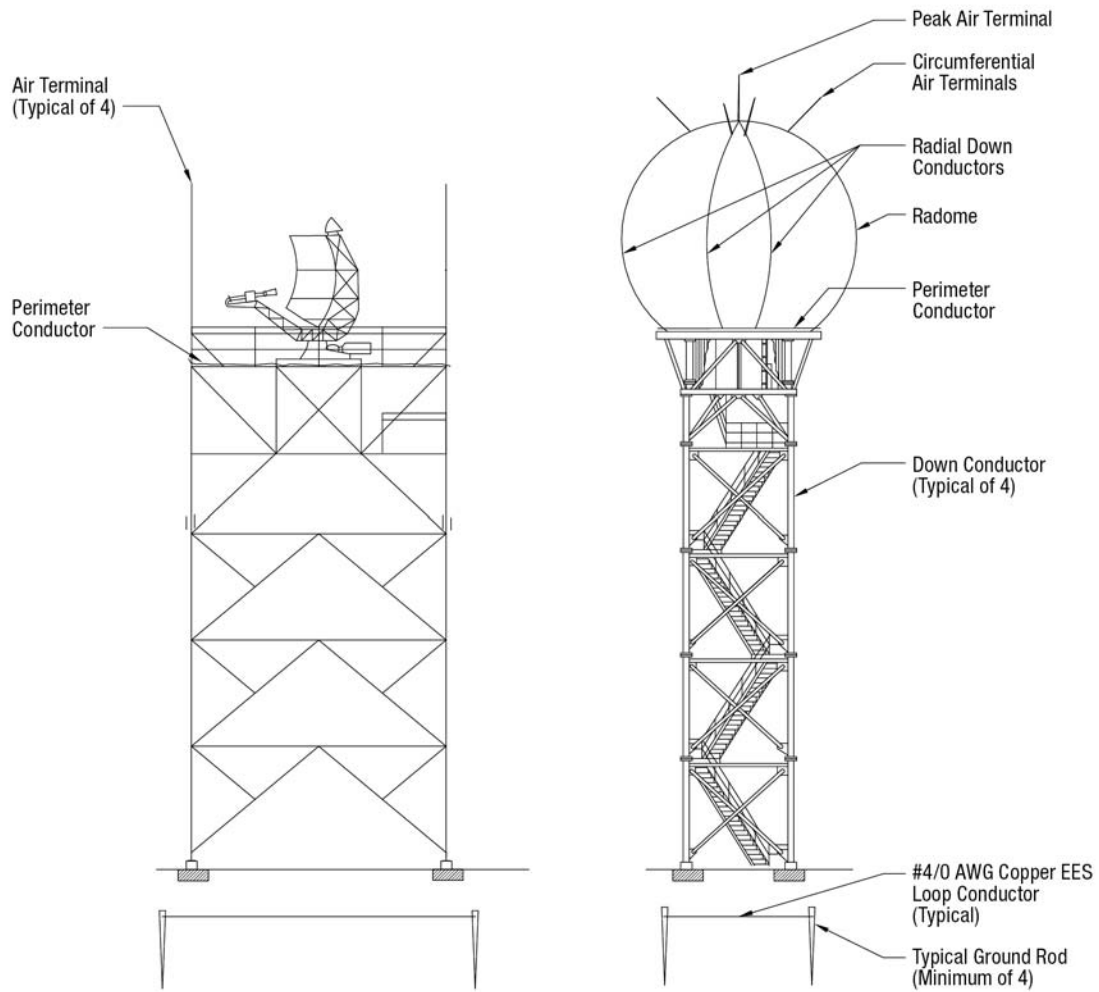

Notes:

1. Bond down conductors to each tower leg section. Exothermically weld down conductor to a 4/0 AWG copper conductor above grade. Route 4/0 AWG conductor through a 1-in. PVC conduit around the foundation concrete pier to 12 in. below grade and connect the conductor to the EES.
2. Where a radome has an electrically continuous frame, the framing may be used in lieu of the lower air terminals.
3. All lightning protection connections shall be free of paint and galvanizing. Scrape all steel free of surface contaminants prior to making exothermic welds or mechanical connections.

**Figure 17. Lightning Protection for Radomes and Radar Antenna Platforms**

### 5.3.3 Antenna Protection

Air terminals shall be located to protect structural towers and buildings, and antennas mounted to towers and on buildings.

Most antennas throughout the FAA can be installed or engineered to be installed within the lightning zone of protection. However, there are select times where engineered solutions cannot be easily installed. Antennas may be deemed sacrificial if either of the following conditions exist:

- a. A 20 foot air terminal (or air terminal installed on a support with the combined height of 20 feet) does not provide proper zone of protection; or
- b. Lightning protection for an antenna will cause radiation pattern distortion.

Sacrificial antennas shall comply with the following:

- a. Bonding and surge protection in accordance with 4.6.3, 5.3.5, and 5.4.3.2; and
- b. The antenna or base is bonded to the lightning protection system.

All sacrificial antennas must be identified by the designer/program office to the SSC (e.g. ASSC). An SRM is one established method that is permitted to meet this requirement.

### 5.3.4 Tower Guying

Provide grounding and bonding for tower guying in accordance with TIA-222.

### 5.3.5 Waveguide, Axial Cable, and Conduit Grounding

Waveguide, axial cable, and conduit located on the tower and feeding into the facility shall be bonded to a bulkhead ground plate mounted on the tower and configured in accordance with 5.4.3.2.

- a. Overhead Cable Runs. Bulkhead plate bonding connections shall be located above the cable path at transition/turning point (90 degree bend point) near the tower's base where the cable transitions horizontally from the tower and enters the facility. Above-ground ferrous conduit located at the facility entrance shall be bonded in accordance with 5.4.3.1.1.
- b. Underground Cable Runs. Bulkhead plate bonding connections shall be located above the cable transition point where the cables enter the facility conduit riser. If cables enter ferrous conduit, the conduit shall be bonded to the EES in accordance with 5.4.3.1.

### 5.3.6 Staircase and Ladder Protection

The metallic staircase or ladder access to the tower shall be exothermically bonded near its base to the EES with a 4/0 AWG copper conductor installed in a location that avoids accidental tripping or striking hazards that could result in personnel injury. Where the staircase or ladder material is not thick enough for an exothermic weld, provide a two-hole hydraulically crimped connection. To ensure electrical continuity, sections of stairs or platforms that are not welded together shall be connected by bonding jumpers.

### 5.3.7 Lightning Protection for Facilities without Buildings or Antennas

Small facilities such as Runway Visual Ranges (RVR) commonly are built without buildings or antennas. Since loss of these facilities can have a significant impact on NAS operations, these facilities shall be included within a zone of protection with either air terminals or overhead catenary wires.

### 5.3.8 Lightning Protection for Fences and Gates

General airport fencing is not subject to the requirements of this standard. Non-FAA owned fencing that is adjacent to FAA facilities shall be protected as mandated by agreement with the owner of the fencing.

Fences shall be constructed using electrically conducting materials (for example, chain link fabric, metal crossbar, stranded wire, etc) using metal posts that extend a minimum of 2 ft below grade into a concrete base. Metallic fence fabric with nonconductive coatings is not permitted, except where corrosive climatic conditions require corrosion protection.

#### 5.3.8.1 Fence Grounding

Provide fence grounding in accordance with the following:

- a. Fence Post Grounding. Provide a ground rod adjacent to the fence post. Locate ground rods at horizontal linear spacing intervals not greater than 100 ft along the perimeter fence line. Provide a 4/0 AWG bare stranded copper conductor, exothermically welded to each ground rod and fence post.
- b. Ground Rod Installation. Ground rod material and installation parameters shall be in accordance with paragraph 4.4.4.1. If soil conditions will not permit installation of ground rods, provide ground dissipation plate(s) in accordance with paragraph 4.4.4.3.
- c. Fence Gate. Provide a 1-in. by 1/8-in. flexible tinned copper bond strap or an insulated 4/0 AWG flexible welding type copper conductor connected between the gate and adjacent fence post. Exothermic welding is recommended for these connections. Install the bonding strap between the gate and post so it will not limit full motion of a swing or slide gate.
- d. Fence Gate Post. Provide a ground rod adjacent to each gate post. Install a 4/0 AWG bare stranded copper conductor, exothermically welded to the ground rod and gate post. Locate the post connection at not greater than 1-ft above grade. Interconnect ground rods located between the gate opening with an exothermically welded 4/0 AWG bare copper conductor buried below frost depth, but not less than 18-in. below ground.
- e. Fence Gate Fabric. Provide a horizontal 6 AWG bare stranded tinned copper conductor threaded continuously through the gate fabric and mechanically bonded to the gate vertical support rails.
- f. Fence Security - Barbed Razor Wire. Bond security wires to the fence post using 6 AWG bare stranded tinned copper conductor and UL listed bonding connectors. Bond across terminations in the security wire using a short piece of the security wire material and UL listed bonding connectors at the same locations in 5.3.8.1 (a), (c), and (d).

- g. Fence Wire Fabric - Chain Link. Attach metallic fence fabric to fence posts with wire ties of the same material.
- h. Proximity to a Facility EES. Portions of a fence that are located within 22 ft of a facility EES shall be bonded to that EES with a 4/0 AWG bare copper conductor exothermically welded to a fence post ground rod. Connections shall be made at a maximum spacing of 100 ft, with a minimum of two connections.

See Figure 18 for illustration of fence grounding installation methods.

#### **5.3.8.1.1 Architectural Style Fences**

Where architectural fences are installed, bond the nearest post with a two-hole hydraulically crimped lug to the ground rod. The security barbed razor wire bonding requirement does not apply to architectural fences.

#### **5.3.8.2 Fences Crossed by Overhead Power Lines**

At locations where overhead power lines cross a fence, bond a fence post no more than 20 ft on each side of the crossing to a ground rod with a bare 4/0 AWG copper conductor. Bond the fence fabric at the top, middle, and bottom of the fence, and bond each strand of security wire placed above the fencing fabric to the grounded post with a bare 6 AWG tinned copper conductor. Where cross-bars or stranded wire is used to support the fence posts, bond the cross-bars or wire supports to the posts.

These connections shall be located 20 ft on side of the overhead power line crossing.

#### **5.3.9 Lightning Protection for Photovoltaic Solar Arrays**

Lightning protection for photovoltaic solar arrays shall be provided in accordance with NFPA-780.

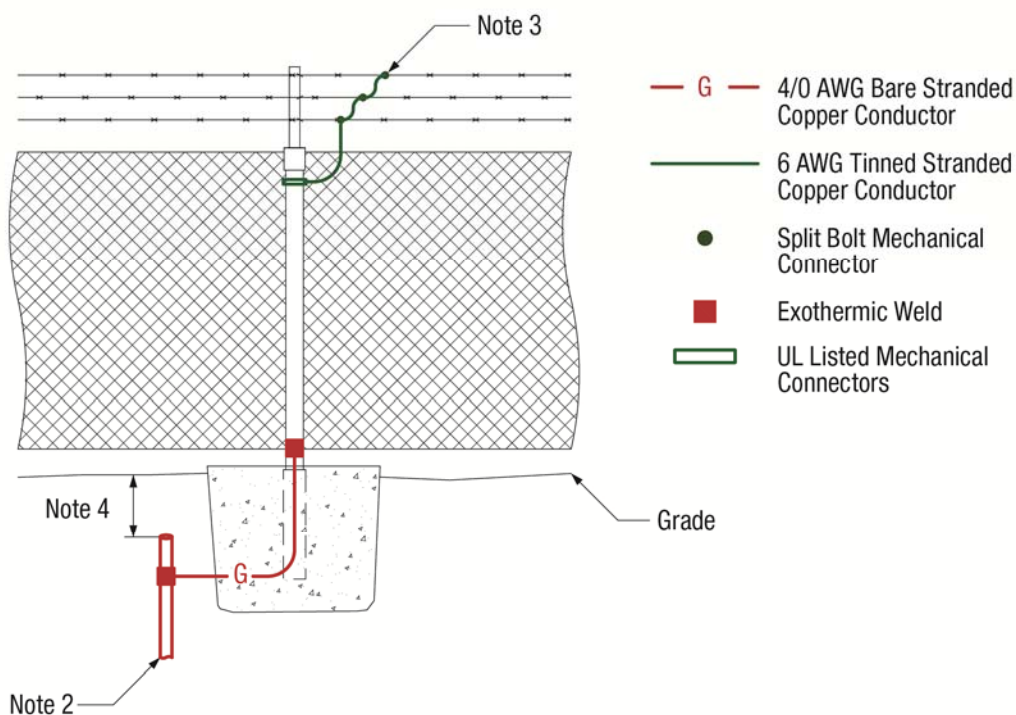

Illustrative Example: Chain Link Fence

Notes:

1. Diagram depicts elemental parts of a typical fencing grounding and bonding installation. Other architectural style fence configurations are possible.
2. Install 10 ft long by 3/4 in. diameter copper clad ground rods at all corners, gate posts, and at intervals not to exceed 100 feet. Exothermically weld each ground rod to the post.
3. Mechanically bond each strand of security wire to the fence post at all corners, gate posts, and at intervals not to exceed 100 feet.
4. 12 in. minimum below grade, but not less than frost depth.

**Figure 18. Fence Grounding**

## 5.4 Facility Transient Protection – Special Conditions

### 5.4.1 General

This section describes additional design considerations for facility transient protection against induced currents from nearby, direct, or indirect lightning strikes. All metallic conduits, conductors, and cables in NAS operational facilities can be subject to currents induced by nearby lightning strikes. These induced effects can adversely affect the operation of sensitive electronic equipment.

### 5.4.2 Existing Metallic Conduit, Conductors, and Cables

Unless not approved by the facility manager, all unused conduits, conductors, and cables shall be removed.

For any remaining unused items, the voltage differential between ends shall be minimized by the following bonding methods:

- a. Unused Metallic Conduits. Metallic conduits shall be bonded to adjacent grounded metalwork at both ends. If not directly bonded, the connection shall use a minimum 6 AWG jumper not longer than 18 in.
- b. Unused Conductors and Cables. These conductors and cables shall be bonded to adjacent grounded metalwork at both ends. Multiple unused conductors shall be grouped together and bonded to the adjacent metalwork, directly or with a bonding jumper.

***Exception.*** Bonding is not required for unused conductors of a structured cable system and vertical risers installed for spare purposes for the following conditions:

1. Vertical cable risers are located no more than 50 ft from grounded metalwork.
  2. Cable circuit length totals are not more than 300 ft and do not pass between facilities.
  3. Cable circulating currents are present; installation of a SPD at one end of the cable may be used for this condition.
- c. Cables With Shields. Unused shielded cables shall be bonded to adjacent grounded metalwork at both ends.

### 5.4.3 Electromagnetic Shielding for Lines, Conductors, and Cables

#### 5.4.3.1 Facility Entrance Conduit

Direct routed conductors and cables, both buried or above ground, shall enter the facility through a minimum of 10-ft ferrous RGS conduit at the exterior face of the building. For above-ground conditions, provide a minimum 10-ft ferrous RGS conduit on the exterior face of the facility at the entrance point. Entrance conduits shall be bonded to the EES with a bare copper stranded conductor, 2 AWG minimum. This entrance conduit, if buried, shall extend a minimum of 5 ft beyond the EES. Entrance conduits can be bonded below or above grade.



***Exception.*** Power feeders maintained by and installed to the requirements of the electric utility provider are exempt from the facility entrance RGS requirement.

#### **5.4.3.1.1 Above-Ground Conduit Entrance to Facility**

At the conduit entrance point, a bonding connection shall be made either to the EES or to a bulkhead connector plate that is bonded to the EES in accordance with paragraph 5.4.3.2. If neither of these bonds is feasible, the bond shall be made to the main or supplemental multipoint ground plate. Provide a minimum 2 AWG stranded copper conductor using exothermic welds or UL-listed pressure connectors for this connection.

#### **5.4.3.1.2 Conduit Joints and Fittings**

Conduit joints and fittings shall be electrically continuous with bonding resistance of 5 mΩ or less between joined parts. Conduit enclosing signal, control, status, power, or other conductors to electronic equipment shall be terminated using conductive fittings to their respective junction boxes, equipment cabinets, enclosures, or other grounded metal structures.

#### **5.4.3.2 Metal Bulkhead Connector Plates**

A metal bulkhead connector plate shall be provided where overhead axial-type cables and waveguides enter the facility. The bulkhead connector plate shall be mounted on the outside surface of the facility or inside the facility within 2 ft of an exterior wall.

- a. **Bulkhead Plate Dimensions.** Ground plates shall be 1/4-in. thick copper or aluminum, and shall have the required number and type of feed-through connectors for axial cable terminations. Plates shall have adequate surface area for bonding all components, such as waveguides, cable shields, and conduits, plus at least two spare positions.
- b. **Bulkhead Plate Connections.** Provide either hydraulically crimped two-bolt-hole style terminal lugs or exothermic welds for conductor connections to the ground plate. Bonding jumpers shall be as short as possible.
- c. **Cable Shields.** Cable shields shall be bonded and grounded, except where the shield must be isolated for proper equipment operation. If external and internal cables are of different sizes, the changeover in cable size is permitted by feed-through connectors at the plate.

Bulkhead plates shall be bonded to the EES with a minimum 4/0 AWG copper cable, color-coded green with a red tracer. When the bulkhead connector plate is located within 6 ft of the building steel, the bulkhead plate shall be connected to the building steel with a 4/0 AWG insulated copper conductor, color-coded green with a red tracer. The building structural steel shall be bonded to the EES using exothermic welds.

Axial type cables, waveguides, and conduits that are not directly bonded to the EES shall be bonded to bulkhead plates with a minimum 6 AWG bonding jumper. The waveguide bonding cable can be connected to the bulkhead waveguide flange with a ring terminal specifically sized for the application. Conduits shall be bonded with a UL-listed U-bolt bonding connector. Axial cable shields shall be bonded with bonding kits sized for the specific cable type. Where SPDs are installed for axial cables, they shall be installed on the antenna or surge side of the metal

bulkhead plate. The SPD ground bus bar shall not be connected to the lightning protection system.

Where a bulkhead plate is installed on top of an ATCT, then the ground conductor can be bonded to building steel as opposed to the EES. Reinforcing bars shall not be used in lieu of building steel.

Where a bulkhead plate is installed on top of a building or base building and the path is longer than a tenth of the difference between building steel and the EES (i.e. building steel is 5 feet away and the EES is more than 50 feet away), then the ground conductor can be bonded to building steel. Reinforcing bars shall not be used in lieu of building steel.

#### **5.4.3.3 Facility External - Buried Power Cables and Conductors**

Buried external power cables and conductors shall have magnetic shielding to prevent damage from coupling of transient currents due to lightning or other electrical sources. This shielding shall be provided by a ferrous metal sheath, ferrous armor, or ferrous RGS conduit.

Cables are permitted to be installed in metallic or nonmetallic conduit where permitted by the NEC. When a conduit is not used for installation of buried cables, the cables shall be identified for direct earth burial (DEB).

Ferrous shielding is recommended for portions of buried power cables and conductors located beyond 300 ft cable length from the facility entrance point. Facility entrance surge protection shall be in accordance with paragraph 4.6.2.1.

##### **5.4.3.3.1 Armored DEB Cables**

Steel armor is the preferred assembly for Armored DEB cables. DEB cable armor shall be bonded to the EES with a 2 AWG conductor prior to entry into a facility or where transitioning to conduit.

DEB cable armor shall also be bonded to the main or supplemental ground plate. If bonding to the main or supplemental multipoint ground plates is not feasible, the armor shall be bonded to the electrical ground bus located at the SDM.

If armor is continued to the electronic equipment, bond the cable armor to the equipment MPG plate.

When the electronic equipment is required to be isolated, bond the cable armor to the equipment SPG plate in accordance with section 5.5.

For initial cable installations, bond resistance shall be less than 5mΩ between joined parts. Complete cable replacement is not required if only a short length of the installation does not meet this requirement.

#### 5.4.3.3.2 Guard Wires

A 1/0 AWG bare copper stranded guard wire shall be provided for buried cables and conductors not routed in ferrous conduit, except as noted below.

***Exception.*** *Guard wires are not required for penetration under runways, taxiways, or topographical features or for 15 kV concentric neutral power cables constructed in accordance with FAA-C-1391d, paragraphs 5.5.7 and 5.5.8. This exception does not apply to concrete-encased PVC duct bank with communication, data, or control cables or to spare ducts that do not contain a corrugated innerduct reserved exclusively for fiber optic cables.*

The guard wire shall be configured as follows:

- a. **Location.** The guard wire should be located at least 8 in. below the finished grade, at minimum height of 10 in. above the cable or cable ductbank, and shall run parallel to the cable or cable ductbank path that is being protected.
- b. **Number of Wires.** Provide one guard wire when the width of the cable ductbank is less than 3-ft wide. Provide additional parallel guard wire runs for cables or cable ductbanks wider than 3 ft, in accordance with the Area of Protection criteria. The guard wires should be spaced approximately 12-in. apart to provide an area of protection for the cable ductbank.
- c. **Area of Protection.** This is the protected area encompassed within a 45 degree zone on either side of the guard wire as illustrated in Figure 19.
- d. **Bonding to EES.** Guard wires shall be bonded to the EES at each end, and to ground rods located at approximately 90-ft intervals along the guard wire path using exothermic welds. The spacing between ground rods must vary by 10 to 20 percent to prevent resonance. Install the ground rods approximately 6 ft on either side of the ductbank trench.
- e. **Airfield Runway Lighting.** Where the cable or cable ductbank runs parallel to the edge of a runway, the ground rods shall be located at least 10 ft clear of the navigation lights in the direction of open available space away from the runway or lighting pathways.

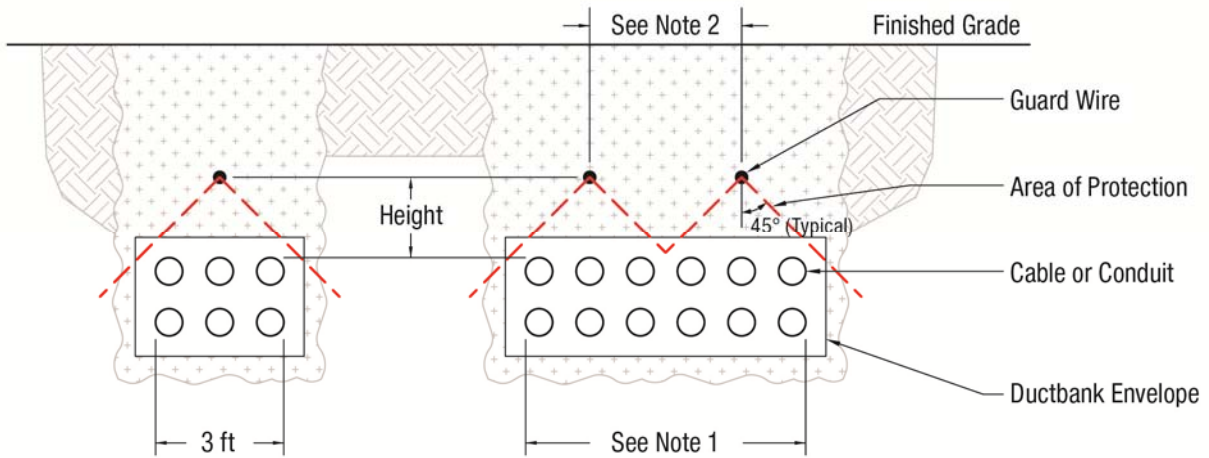

Notes:

1. Provide additional parallel guard wire runs for cables or cable ductbanks wider than 3 ft.
2. The spacing intervals between the center lines of the guard wires should not exceed twice the height distance between the guard wire and ductbank.

**Figure 19. Buried Guard Wire Detail for Underground Cables or Cable Ductbanks**

**5.4.3.3.3 Buried Landlines**

The preferred type of buried landline that represents best engineering practice is fiber optic type. Fiber optic cable does not require electromagnetic shielding and is exempt from these requirements.

Metallic buried landlines that carry NAS critical, essential, or mission support services to a facility shall have a ferrous shield or be enclosed in ferrous RGS conduit. Ferrous shielding is recommended for portions of these buried landlines located beyond 300-ft cable length from the facility entrance. Facility entrance surge protection shall be provided for these landlines in accordance with paragraph 4.6.3.

**5.4.4 Balanced Pair Cables**

When possible, shielded circuits should be provided for signal and control circuits routed external to electronic equipment. Balanced pair cables shall be two-conductor circuits.

**5.4.5 Fiber Optic Cable**

When possible, fiber optic cables should be used in lieu of metallic cables. Fiber optic cables are inherently not susceptible to electromagnetic interference (EMI) or the induction fields produced by lightning, and are not required to be installed in ferrous conduit or have conductive armor for shielding. The use of fiber optic cables without a conductive shield or armor is permitted. Suppression components are not required for fiber optic cables.

- a. Facility Entrance. The conductive armor of external fiber optic cables at the facility entrance point shall be bonded to the EES. Use 2 AWG bare copper conductor when bonding directly to the EES. When bonding connection to the EES uses an SPD, the

SPD bonding conductor shall be a 4 AWG stranded copper conductor insulated green with an orange tracer.

- b. Facility Cabling. When the cable is internal to the facility and includes metallic electrically conductive sheaths or strength members, the sheaths shall be grounded to any SRS. When the electronic equipment is required to be isolated, bond the cable armor to the equipment SPG plate in accordance with section 5.5. To prevent circulating ground currents in the cable armor, an SPD located at one end of the cable may be used for grounding.
- c. Transmitter and Receiver Modules. Fiber optic transmitter and receiver modules shall be contained in ferrous enclosures and bonded to the nearest SRS. Penetrations of the equipment enclosures shall be gasketed or constructed to limit RF coupling. SPDs for the metallic signal and power circuits shall be installed as equipment level protection at the fiber optic receiver or transmitter equipment entrance, and bonded to the equipment enclosure chassis. The transmitter and receiver modules shall have 90 dB of attenuation against EMI.

#### **5.4.6 Interior Wiring, Conductors, and Cables**

Permanent single conductors, cables and wiring shall be in ferrous raceway systems, such as RGS conduit, intermediate metal conduit (IMC), electrical metallic tubing (EMT) conduit, cable tray, or wireway, except when prohibited by NEC. Flexible metal conduit (FMC) is permitted when installed in accordance with FAA-C-1217.

Cable tray systems comprising single rail or wire construction are permitted where the installation of conventional ladder cable tray is impractical, provided the cable tray system meets the following requirements:

- a. Suitable for use and classified by UL as an EGC.
- b. Installed in accordance with manufacturer instructions to maintain the UL classification.

##### **5.4.6.1 Metal-Clad Cable - Type MC**

Type MC cable is permitted when installed in accordance with FAA-C-1217 and where all of the following conditions are met:

- a. The MC cable shall include a steel armor of interlocking metal tape or sheath construction to form a ferrous magnetic exterior shield. MC cable with an aluminum exterior shield is prohibited.
- b. Both ends of the MC cable shall be terminated using UL-listed compression fittings recommended by the OPR of this document.
- c. The MC cable shall include a separate internal equipment grounding conductor or wire.

When MC cables are installed in MC cable tray, the following conditions shall be met:

- a. The MC cable shall be UL-listed and marked suitable for use in metallic cable tray (hereinafter referred to as MC cable tray).

- b. The MC cable tray shall be used exclusively for MC cable and type UL-listed raceways for power distribution.
- c. The MC cable tray shall be separated from all other cable trays that transport non-axial communications, signal, and/or control cables or conductors by at least 12 in. The MC cable tray shall not carry more than 90 individual power branch circuits.
- d. The MC cable bend radius shall be in accordance with the NEC and cable manufacturer installation instructions, but not less than 8 in.

## **5.5 Single Point Ground System (SPG) – Special Conditions**

### **5.5.1 General**

An SPG shall be provided when required by the electronic equipment or requested by the electronic equipment vendor. FAA facilities that do not use single-point-ground equipment are not required to install an SPG. The SPG shall be isolated from the power grounding system, the lightning protection system, MPG, or SRGG and SRGP systems, except at the main ground plate. The SPG shall be terminated at the main ground plate or to the EES, whichever is closer. The SPG shall be configured to minimize conductor lengths. Conductive loops shall be avoided by maintaining a trunk and branch arrangement as shown in Figure 20.

### **5.5.2 Isolation between SPG and Other SRS Systems**

The minimum resistance between the SPG and the MPG, SRGG, or SRGP systems shall be 10 MΩ. The resistance shall be measured after the complete network is installed and before connection to the EES or SRS system at the main ground plate.

### **5.5.3 Resistance of Bonds**

The maximum resistance of a bond connection from a conductor to a ground plate shall not be greater than 1 mΩ.

### **5.5.4 SPG - Ground Plates**

Main, branch, and feeder ground plates shall be copper and at least 4 in. wide and 1/4 in. thick. The plates shall be mounted to nonconductive material of sufficient cross-section to rigidly support the plates after all conductors are connected. Bolts or other devices used to secure the plates in place shall be insulated or shall be of a nonconducting material. The plates shall be mounted in a manner that provides ready accessibility for inspection and maintenance.

See Table 4 for the single ground plate installation requirements.

### **5.5.5 SPG - Ground Conductors**

Ground conductors shall be insulated copper conductors color-coded green with a yellow tracer.

#### **5.5.5.1 Main SPG Conductor**

Where an SPG is established directly from the EES, the SPG main conductor shall be an insulated 500 kcmil copper conductor not exceeding 50 ft in length. The main ground conductor shall be connected to the EES by an exothermic weld in accordance with paragraph 4.2.3.1.

### **5.5.5.2 Trunk and Branch Ground Conductors**

Provide an insulated trunk ground conductor to interconnect all branch ground plates to the main ground plate as illustrated in Figure 20. Provide insulated copper branch ground conductors to interconnect feeder plates to branch ground plates. Conductor insulation shall be green with yellow tracer. Trunk and branch conductors shall be connected to ground plates by exothermic welds or UL-listed double-bolted connections in accordance with paragraph 4.2.3.4, and shall be mounted as shown on the facility drawings.

Trunk and branch conductors shall be routed using the shortest possible path.

- a. Conductors Shorter than 400 ft. Trunk conductors shall be 4/0 AWG insulated copper conductors where the conductor length to the farthest feeder plate in the system is no more than 400 ft from the EES via the conductor runs.
- b. Conductors Longer than 400 ft. For longer runs, select a conductor size to provide a cross-sectional area of 500 cmil per linear foot of conductor, but in no case that the conductor is smaller than 250 kmil.

### **5.5.5.3 Electronic Equipment SPG Conductors**

The conductor from the feeder ground plate (branch ground plate when there are no feeder ground plates in the conductor run) shall be connected to the isolated ground terminal or bus on the electronic equipment. This conductor shall be sized in accordance with Table 3.

### **5.5.5.4 Interconnections**

Connections to the SPG shall be made on ground plates or buses. Split bolts and other connections to existing conductors are not allowed.

### **5.5.6 Labeling**

The SPG shall be clearly labeled to preserve its identity as described in the following paragraphs.

#### **5.5.6.1 Conductor Identification**

SPG conductors shall be labeled in accordance with paragraph 4.7.3.1.6.

#### **5.5.6.2 Ground Plate Labeling**

Ground plates shall be installed according to Table 4.

### **5.5.7 Protection**

Provide protection for conductors in the SPG subject to physical damage by use of conduit, floor trenches, routing behind permanent structural members, or other approved means. Single-point ground conductors shall be isolated from contact with any metal elements.

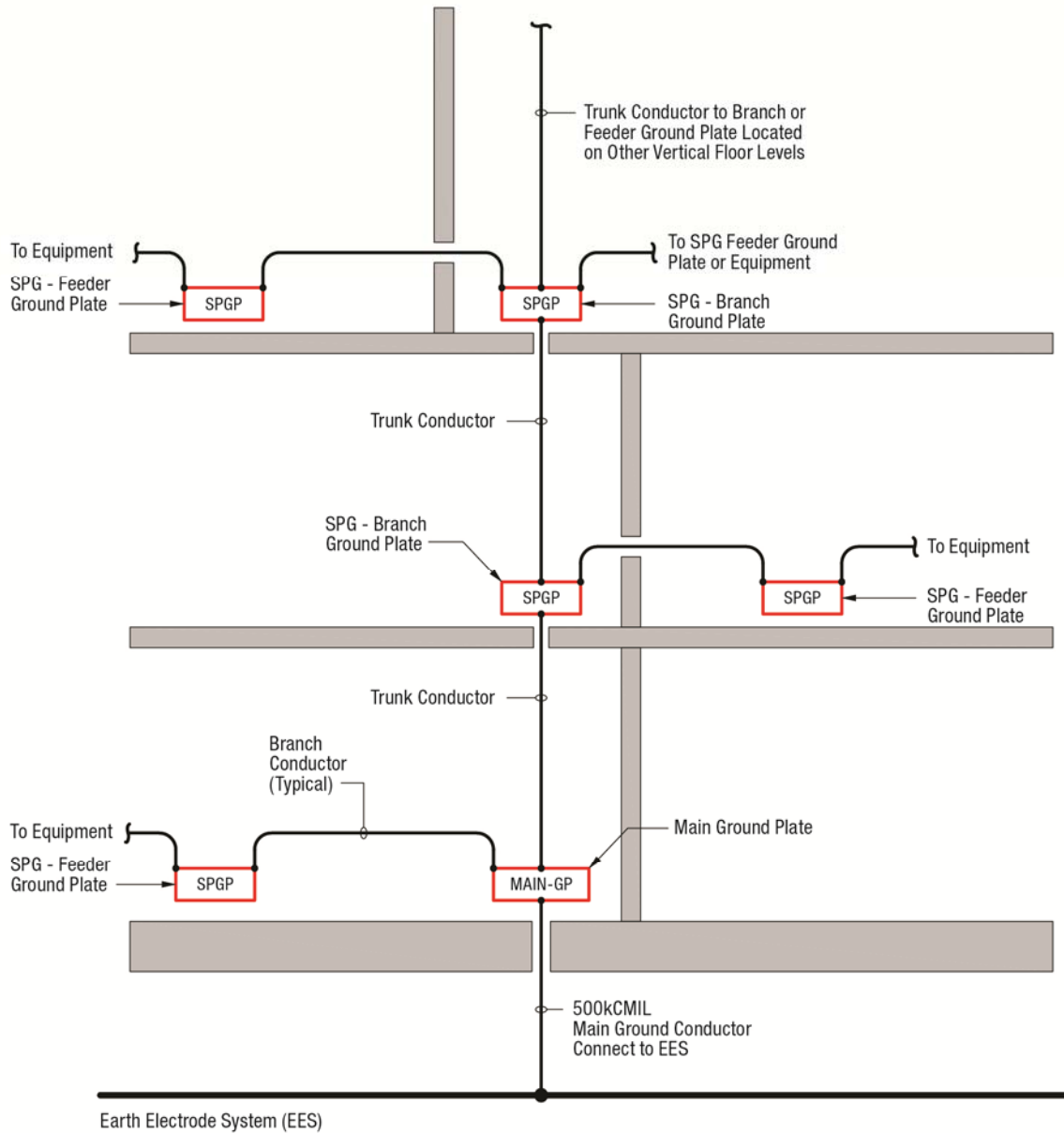

**Figure 20. Single-Point Ground System Installation – Illustrative Example**



## **5.6 NAS Electronic Equipment – Interface and Procurement Requirements**

### **5.6.1 General**

This section provides detailed performance and interface requirements for installation and procurement of NAS electronic equipment. Electronic equipment installed in NAS facilities shall comply with the requirements herein that address the following:

- a. Electronic Signal Lines and Cables – Shielding
- b. Signal, Control, and Data Line Entrance – Transient Protection
- c. Equipment Power Entrance – Transient Protection
- d. Electronic Equipment – Grounding and Bonding
- e. Equipment – Signal Grounding and Bonding
- f. Equipment Shielding Requirements
- g. Circuit and Equipment ESD Design Requirements

### **5.6.2 Electronic Signal Lines and Cables - Shielding**

Electronic signal lines shall be shielded twisted pairs with an insulated covering. Cables consisting of multiple twisted pairs shall have the individual shields isolated from each other. Cables shall have an overall shield with an overall insulated covering.

#### **5.6.2.1 Electronic Signal Return Path**

The electronic signal return path shall be routed with the circuit conductor. For axial circuits, the shield serves this purpose. The electronic equipment case and SRS shall not be used as a signal return conductor.

#### **5.6.2.2 Termination of Individual Shields**

Termination of individual shields shall be in accordance with paragraph 4.8.3.2.

#### **5.6.2.3 Termination of Overall Shields**

Termination of overall shields shall be in accordance with paragraph 4.8.3.3.

### **5.6.3 Signal, Control, and Data Line Entrance – Transient Protection**

Procurement organizations are responsible for ensuring that electronic equipment, such as radars, NAVAIDS, and transmitters shall be provided with transient protection to reduce surges and transients to below the equipment transient susceptibility level. Signal, control, data line, and antenna cabling entrance transient protection shall be provided at the facility entrance point and at electronic equipment. Equipment SPDs shall be an integral part of the equipment, installed either internally or on the exterior of the equipment. Coordination of these protectors shall be addressed and completed in the system design stage and should not be delegated to field personnel during construction.

Equipment susceptibility level is defined as the transient level on the signal, control, or data lines that cause damage, degradation, or upset to electronic circuitry connected to the line. Transient protection for these lines is in addition to the facility transient protection levels specified in

paragraphs 5.7.2 through 5.7.4. Procurement organizations are responsible for ensuring that testing is performed to establish voltage, current, and energy levels that will damage components, shorten operating life, or cause operational upset to the equipment. These tests shall include electrical and electronic equipment components exposed to the effects of surges or transients.

The procurement organization shall ensure that facility and electronic equipment entrance transient protection is coordinated to limit transients at the equipment to below the equipment susceptibility level. Requirements of this paragraph shall be included in the comprehensive control and test plans included in paragraph 5.9.2. The following characteristics shall be evaluated:

- a. Component Damage Threshold. The component damage threshold is the transient level that renders the component nonfunctional or operationally deficient. Voltage is usually the relevant parameter for solid-state components.
- b. Component Degradation Level. The component degradation level is the transient voltage or energy level that shortens the useful life of the component.
- c. Operational Upset Level. The operational upset level is the transient voltage or energy level that causes an unacceptable change in operating characteristics for longer than 10 milliseconds for analog equipment or a change of logic state for digital equipment.

**5.6.3.1 Lines and Cables Requiring Protection**

Surge protective devices shall be placed on both ends of signal, data, antenna, and control lines and cables longer than 10 ft where connecting pieces of electronic equipment are not located and bonded to the same SRS, or where the SRS ground system is located in different rooms or on different building floor levels, as illustrated in Figure 21. Electronic equipment shall be protected as specified in paragraph 5.6.3.

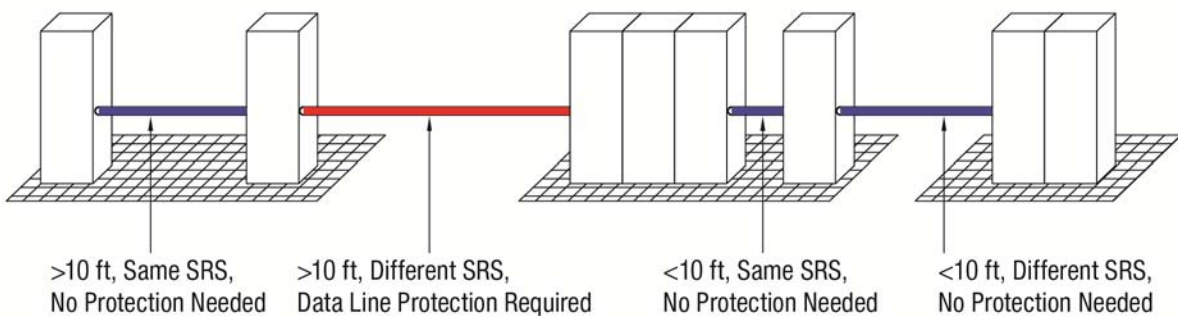

**Figure 21. Lines and Cables Requiring Protection**

**5.6.4 Equipment Power Entrance – Transient Protection**

SPDs, components, or circuits for the protection of electronic equipment power lines shall be provided by the equipment manufacturer as an integral part of electronic equipment mounted internally or on the exterior of the equipment at the cable entrance point. These devices shall be located at the ac power conductor entrance to electronic equipment housed in a shielded,

compartmentalized enclosure. SPDs at equipment shall provide a clamping level less than the equipment operational upset susceptibility level as defined in paragraph 5.6.3c and shall conform to Table 8, Table 9, and Table 10.

- a. Maximum Continuous Operating Voltage (MCOV). The MCOV is the maximum rms voltage an SPD can withstand while operating continuously at maximum temperature without degradation or change to any of its parameters greater than +/-10 percent. The MCOV shall be at least 10 percent above the nominal system voltage, and leakage current, as defined below, shall not be exceeded.
- b. Leakage Current. The dc leakage current shall be less than 1 mA for voltages at or below the dc voltage value of 1.414 x MCOV.
- c. Clamping Discharge Voltage (CDV). The CDV is the maximum voltage that appears across an SPD output terminal while conducting surge currents. To ensure performance in the linear region without impacting the device lifetime performance, the CDV values measured at 3 kA for an 8/20  $\mu$ s current impulse waveform shall not change more than 10 percent over the operating life of the SPD as defined in Table 10.
- d. Overshoot Voltage. Overshoot voltage is the surge voltage level that appears across the SPD terminals before the device turns on and clamps the surge to the specified voltage level. Overshoot voltage shall not exceed two times the SPD clamping voltage for more than 10 ns.
- e. Self-restoring Capability. The SPD shall automatically return to its off state after surge dissipation when line voltage returns to normal.
- f. Operating Lifetime. The SPD shall safely dissipate the number and amplitude of surges listed in Table 10.
- g. Fusing. The SPD overcurrent protection shall not increase the clamp voltage of the SPD and shall pass the surge current levels listed in Table 10 up to the 20 kA level without opening. Fusing shall be coordinated with the power source overcurrent protection scheme.

#### 5.6.4.1 Slope Resistance

The purpose of this parameter is to establish a system that ensures SPD device coordination for equipment protection. The slope resistance  $R_{\text{slope}}$ , as calculated by the formula below, shall comply with Table 8:

$$R_{\text{slope}} = (V_{10} - V_1)/9000$$

Where  $V_{10}$  is the clamping voltage measured at 10 kA for an 8/20  $\mu$ s waveform and  $V_1$  is the clamping voltage measured at 1 kA for an 8/20  $\mu$ s waveform.

The values of  $V_{10}$  and  $V_1$  shall be based on actual measured values of SPD performance testing and not calculated values.

**Table 8. Electronic Equipment Power Entrance SPD - Slope Resistance ( $R_{slope}$ )**

Location	Slope Resistance Value
Electronic equipment power entrance	60 mΩ minimum

**5.6.4.2 SPD Voltage Protection Rating -  $V_3$**

SPD voltage protection rating shall be based on actual measured values of SPD performance testing and not calculated values. Voltages to be achieved during testing at 3 kA for an 8/20 μs current impulse waveform are shown in Table 9. All voltages shall be measured at the device terminals. The 8/20 μs waveform shall not lead or lag the voltage waveform by more than 30 degrees.

**Table 9. Electronic Equipment Power Entrance SPD - Voltage Protection Rating ( $V_3$ )**

Location	System Voltage (V)	SPD Voltage Protection Rating ( $V_3$ per mode)	Limit
Electronic equipment power entrance	120/208 or 120/240	550 L-N, L-G 850 L-L	Minimum
	277/480	850 L-N, L-G 1350 L-L	Minimum
	380 Delta	1350 L-L, L-G	Minimum
	480 Delta	1350 L-L, L-G	Minimum

**Table 10. Electronic Equipment Power Entrance SPD – Surge Current Lifetime Rating**

Surge Current Level Amplitude with an 8/20 μs Waveform (see note 1) (kA)	Number of Surges Lifetime
1	100
10	25
20	1

Note:  
1. Each level of surge current and the number of lifetime surges required represents a single lifetime of the SPD.

**5.6.4.3 Electronic Equipment dc Power Supplies – Transient Protection**

Procurement organizations are responsible for ensuring that equipment power supplies that use 60 Hz power to derive dc operating voltages for solid-state electronic equipment supporting the NAS shall have transient suppression components installed for each power supply output line. The suppression components shall be bonded to the protection equipment chassis. The chassis side of the suppressor enclosure shall be bonded to the rectifier output ground connection. The

suppressor should be located as close as possible to the rectifier grounding connection. Suppression components for power supply's rectifier output lines shall comply with following operating characteristics:

- a. Operating Lifetime. Transient suppressors shall safely dissipate 1,000 surges at 200 A amplitude for a 1.2/50  $\mu$ s current impulse waveform. Methods of testing shall be in accordance with the guidance in IEEE C62.45.
- b. Limiting Voltage. Voltage shall be limited to a point 20 percent below the maximum peak inverse voltage (PIV) of the dc rectifier.

**5.6.5 NAS Electronic Equipment Enclosures and Assemblies - Grounding and Bonding**  
Bonding connections for electronic equipment enclosures and assemblies shall be prepared and completed in accordance with the installation conditions and requirements provided herein.

**5.6.5.1 Electronic Equipment Cabinets, Racks, and Cases**

Cabinets, racks, and cases shall be provided with a grounding terminal or bus assembly whereby a bonding jumper or wire can be mechanically connected through an electrically conductive surface to the chassis frame. The metal enclosure of each individual unit or piece of electronic equipment shall be bonded to its cabinet, rack, or directly to the SRS or MPG system.

**5.6.5.2 Equipment Enclosures - Isolated Grounding Receptacles**

Isolated receptacles installed in accordance with the NEC are permitted for reduction of electrical noise. Isolated EGCs used for these receptacles shall be color-coded green with red and yellow tracers at each termination, and where passing through an enclosure without termination.

**5.6.5.3 Portable Equipment (with Grounding Conductor)**

Portable electrical or electronic equipment cases, enclosures, and housings shall be considered to be effectively grounded for fault protection through the EGC of the power cord, if positive continuity is provided between the case, enclosure or housing, and the receptacle ground terminal. The power cord EGC shall not be used for signal grounding.

**5.6.5.4 Alternating Current Power Filters**

Filter cases shall be bonded directly to the equipment case or enclosure in accordance with paragraph 5.6.5.5. Filter leakage current shall not exceed 5 mA per filter. Transient suppression devices, components, or circuits shall be installed in accordance with paragraph 4.6.3.

**5.6.5.5 Electronic Equipment Enclosure Bonding**

Where subassemblies and equipment are in physical contact with the equipment enclosure, they shall be bonded directly with the enclosure and mounting surfaces.

**5.6.5.5.1 Enclosure Subassemblies for Equipment Mounting**

Use the maximum possible contact area when bonding subassemblies to the equipment chassis. Raceway penetrations, filters, and connectors shall be bonded at the periphery to the subassembly enclosure to maintain shield effectiveness. Enclosure covers and mounting trim

shall be securely fastened to the enclosure. COTS equipment is considered a sealed unit and does not require additional internal bonding for the purposes of this requirement.

#### **5.6.5.5.2 Electronic Equipment**

The equipment chassis components shall be bonded together and directly to the rack, frame, or cabinet to which they are mounted. Clean flange surfaces and the bonding contact surface in accordance with paragraph 4.2.4.1. Fasteners shall maintain sufficient pressure to ensure surface contact to meet the bond resistance requirements in paragraph 4.2.1.1. Captive nuts, sheet metal screws, and tapping screws shall not be used for fasteners. If equipment operation is necessary when partially or completely withdrawn from its mounted position, the bond shall be maintained by an effective area of direct metal-to-metal contact or by the use of a flexible bonding strap. Mechanical designs shall employ direct bonding, without bonding jumpers, whenever possible.

***Exception.** Self-drilling (tapping) metal screws are permitted to make a physical connection between metal back panels within equipment cabinet/enclosures for conditions where equipment access is not available to the opposite side of the bond connection.*

#### **5.6.5.5.3 Connector Mounting**

Connectors shall be mounted so that electrical contact is maintained between the connector body and the metal mounting panel. The connector flange shall be fastened to equipment enclosure to ensure direct contact between components for effective bonding. The connector flange surface and the enclosure contact area shall be cleaned in accordance with paragraph 4.2.4.1. Nonconductive material shall be removed from the contact area as illustrated on Figure 22. After mounting each connector, the completed bond shall be sealed and finished for corrosion protection in accordance with paragraph 4.2.4.3.

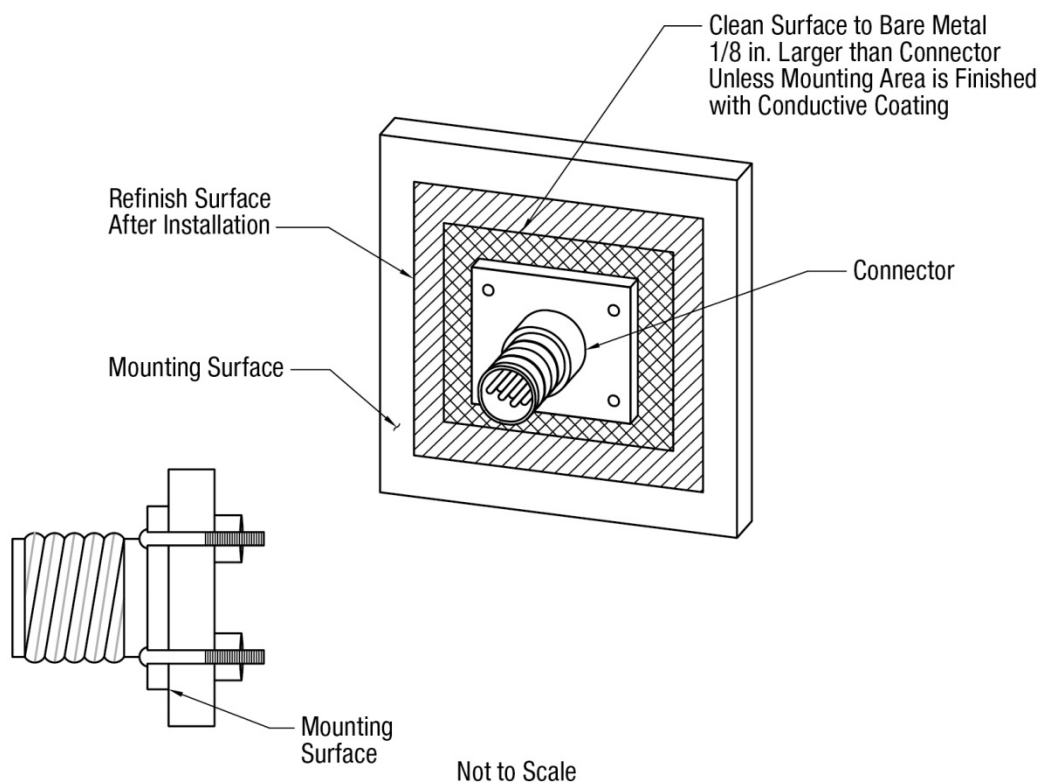

Notes:

1. The connection detail depicts an illustrative example and is exaggerated for clarity.

**Figure 22. Bonding of Connectors to Mounting Surface**

**5.6.5.5.4 Shield Terminations**

Cable shields shall be terminated in accordance with paragraphs 4.8.3.2 and 4.8.3.3. Axial cable shields shall be fastened to the cable connector shell with a compression fitting. A soldered connection is permitted to improve conductivity of the shielding joints in accordance with paragraph 4.2.3f. The cable shall withstand the anticipated use without degradation in shielding efficiency performance. Axial cable connectors shall be corrosion resistant in accordance with FAA-G-2100. Low frequency shields shall be soldered in place or, if solderless terminals are used, the compressed fitting shall afford maximum contact between the shield and the terminal sleeve. The cable shield casing shall be exposed less than 1 in. from the internal conductors of the cable as illustrated in Figure 13.

**5.6.5.5.5 RF Gaskets**

Conductive gaskets shall be corrosion resistant, electrically conductive to meet the resistance requirements of paragraph 4.2.1.1, and resilient to ensure the shielding effectiveness of the bond. Surfaces in contact with the gasket shall be smooth and free of insulating films, corrosion, moisture, and paint. The gasket shall be firmly affixed to the bonding surface by conductive cement and screw fasteners, a milled slot or other means that do not interfere with the effectiveness of the gasket. These methods shall prevent lateral movement or dislodging of the

gasket when the bond is disassembled. Gaskets shall be a minimum of 1/8-in. wide. The gasket and the contact surfaces shall be protected from corrosion.

## **5.6.6 NAS Electronic Equipment – Equipment Grounding and Bonding**

### **5.6.6.1 Equipment Input and Output Electronic Signals**

If a common signal reference is used, low-frequency analog input and output signals shall be balanced with respect to the signal reference. Maintain complete isolation between the SPG and the MPG, SRGG or SRGP system, except at the main ground plate or EES.

### **5.6.6.2 Multipoint Grounding of Electronic Equipment**

Where permitted by circuit design requirements, internal ground references shall be bonded directly to the chassis and the equipment case. Where mounted in a rack, cabinet, or enclosure, the electronic equipment case shall be bonded to the racks, cabinet, or enclosure in accordance with paragraph 5.6.5.1. The dc resistance between any two points within a chassis or electronic equipment cabinet serving as ground shall be less than 25 m $\Omega$  total and not more than 2.5 m $\Omega$  per joint. Shields shall be provided where required for personnel protection and EMI reduction.

#### **5.6.6.2.1 Prevention of Resonance in Bonding Straps**

Due to resonance from a single bonding strap, two widely spaced straps of unequal length shall be used to connect equipment to the multipoint grounding bus in the equipment cabinet. Bonding connections shall be as short as possible and sized in accordance with Table 3.

### **5.6.6.3 Single-Point Grounding of Electronic Equipment**

If electronic equipment performance necessitates an isolated SPG system for proper operation, then equipment and installation shall comply with the following:

- a. SPG System. The SPG or plane shall be isolated from the electronic equipment case. If a metal chassis is used as the SPG, the chassis shall be floated relative to the case. The SPG system shall be designed such that electronic equipment SPG may be interfaced with other electronic equipment without compromising the system. Provide filtering if this SPG is required to be isolated from high frequencies.
- b. SPG Conductor and Plate System. The system shall not form a conductive ground loop and it should be set up as a signal drain.

#### **5.6.6.3.1 Single-Point Isolation of Input and Output Signal Requirements**

The “high” and “low” sides of input and output signals shall be isolated from the electronic equipment case and balanced with respect to the signal reference. Operating and adjusting controls, readouts, indicating devices, protective devices, monitoring jacks, and signal connectors shall be designed to isolate both the high and low side of the signal from the case.

#### **5.6.6.3.2 Single-Point Isolation of Case Requirements**

The isolation between the SPG terminals and the case shall be 10 M $\Omega$  or greater with external power, signal, and control lines disconnected from the electronic equipment.



#### 5.6.6.3.3 Equipment Power Input Isolation Requirements

The isolation between the SPG terminal and each power conductor (including ac neutral) shall be 10 M $\Omega$  or greater with the equipment power switch in the “on” position and the equipment disconnected from its power source.

#### 5.6.6.3.4 Equipment Single-Point Ground Terminals

An insulated SPG terminal shall be provided on each electronic equipment case where an isolated signal reference is required. The SPG reference for the internal circuits shall be connected to the SPG terminal. This terminal shall be used to terminate cable shields as appropriate, and to connect the isolated signal ground of the electronic equipment to the SPG in the facility. A connector pin, screw, terminal strip, insulated stud, jack or feed-through, or an insulated wire are acceptable terminations if each terminal is clearly marked, labeled, or coded in a manner that does not interfere with its function. These marks, codes, or labels shall be permanently affixed and use green identification with yellow stripes. Wire insulation shall be green with a yellow tracer.

#### 5.6.6.3.5 Connection of Electronic Equipment to the SPG

Each equipment SPG terminal shall be connected to the facility SPG in accordance with the following:

- a. Individually Mounted Equipment. Individual units or pieces of electronic equipment that should not be mounted with other electronic equipment due to their location or function shall have an insulated copper conductor bonded from SPG terminal as specified in paragraph 5.6.6.3.4 to the nearest SPG system. This conductor shall be sized in accordance with Table 3.
- b. SPG Bus Bar. If two or more units or pieces of electronic equipment are mounted together in a rack or cabinet, then a single-point ground bus bar shall be installed as shown in Figure 23. The bus bar shall be copper and shall provide a minimum cross-sectional area of 125,000 cmils, e.g., a 1x1/8-in. bus bar. The bus bar shall be drilled and tapped for No. 10 screws, and the holes shall be located as required by the relative location of the isolated SPG terminals on the electronic equipment. The bus bar shall be mounted on insulating supports that provide at least 10 M $\Omega$  resistance between the bus bar and the rack or cabinet.
- c. Interconnecting SPG Terminals to SPG Bus Bar. Each electronic equipment isolated SPG terminal shall be interconnected to the SPG bus bar by means of a solid conductor of sufficient cross-sectional area to provide a maximum resistance of 5 m $\Omega$ , or a flexible tinned copper bond jumper sized in accordance with Table 3. The bond jumper shall be insulated or mounted in such a manner to maintain the required degree of isolation between the reference conductor and the enclosure. The bond jumper shall be connected to the equipment SPG bus bar at a point nearest the equipment SPG terminal in order to minimize the conductor length. An insulated copper conductor shall be installed from the equipment SPG bus bar to the nearest SPG grounding system as illustrated in Figure 23.

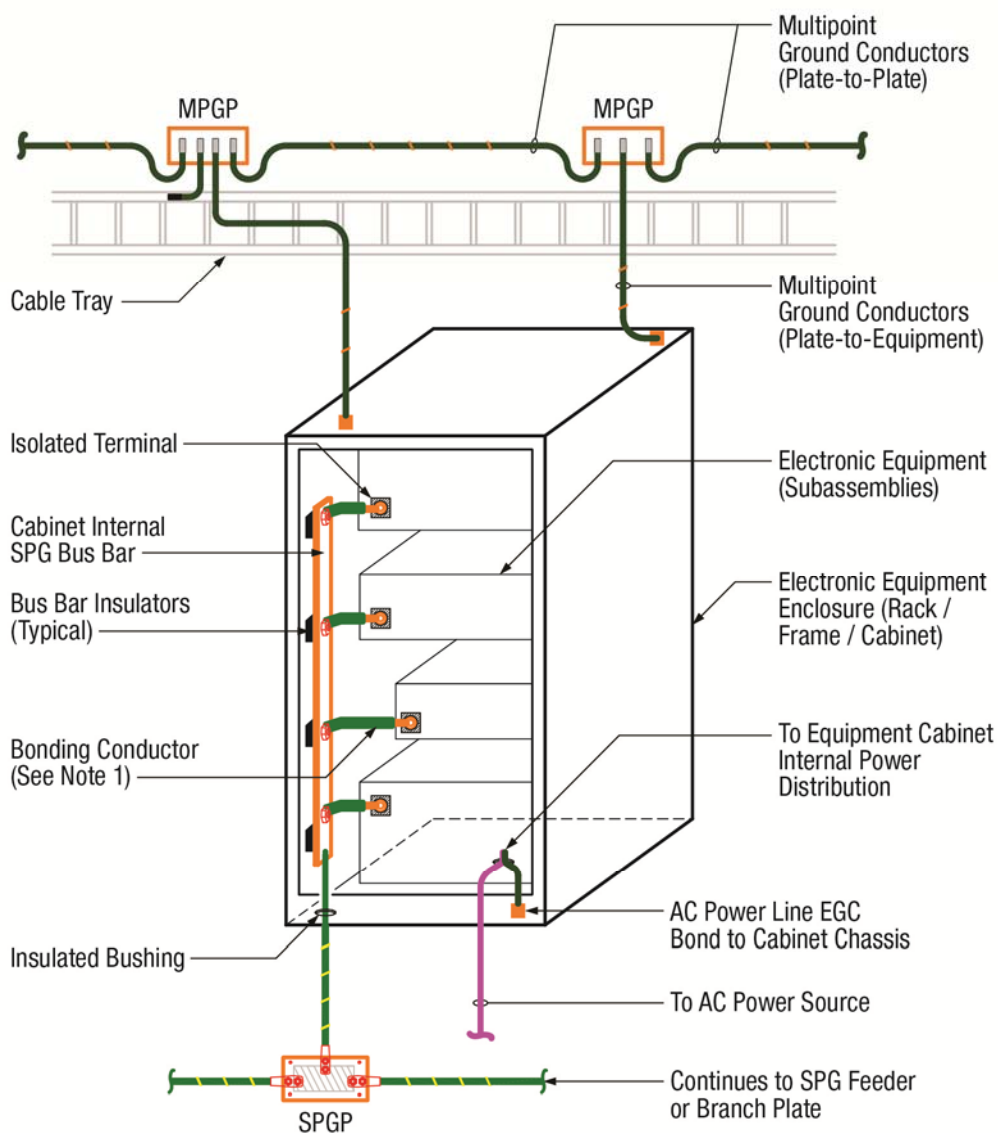

Note:

1. The conductor wire size for bonding conductors from electronic equipment to internal cabinet SPG bus bar shall be based on Table 3.

**Figure 23. Single Point Ground Bus Bar Installation in Rack or Cabinet**

**5.6.7 Equipment Shielding Requirements**

**5.6.7.1 Control of Apertures**

Unnecessary apertures shall be avoided. Only those shield openings required to achieve proper functioning and operation of the equipment may be provided. Controls, switches, and fuse holders shall be mounted such that metal-to-metal contact is maintained between the cover housing of the devices and the case. Metal control shafts shall be grounded in accordance with

paragraph 5.6.7.2. Close-fitting metal sleeves peripherally bonded to the case shall be provided only where nonconductive control shafts are necessary. The length of the sleeve shall be no less than four times its diameter. Lights shall be filtered or shielded as needed to maintain the required degree of shielding effectiveness. Openings provided for enclosure ventilation and moisture drainage shall be configured to maintain the effectiveness of the overall enclosure shielding.

#### **5.6.7.2 Metal Control Shafts**

Metal control shafts shall be grounded to equipment cases through a low impedance path provided by close-fitting conductive gaskets, metal finger stock, or grounding nuts.

#### **5.6.7.3 Shielded Compartments**

Shields shall be bonded to the chassis for fault protection in accordance with section 4.2.

#### **5.6.7.4 Gaskets for Shielding Systems**

Conductive gaskets conforming to paragraph 5.6.5.5 may be provided at joints, seams, access covers, removable partitions, and other shield discontinuities to the extent necessary to provide interference-free operation of the equipment under normal use and environmental conditions. Finger stock used on doors, covers, or other closures subject to frequent openings shall be installed in a manner that permits routine cleaning and maintenance.

#### **5.6.7.5 Filter Integration**

Filters on power, control, and signal lines shall be installed in a manner that maintains the integrity of the shield. Alternating current power filters shall be shielded completely with the filter case grounded in accordance with paragraph 5.6.5.4. Filters for control and signal lines shall be placed as close as possible to the point of penetration of the case to avoid long, unprotected paths inside the equipment.

### **5.6.8 NAS Electronic Equipment - Electrostatic Discharge Protection**

ESD protection shall be provided in accordance with section 5.8.

- a. Equipment Circuit Design and Layout. The design, layout, and packaging of assemblies, circuits, and components integrated into electrical and electronic equipment shall incorporate methods and techniques to reduce susceptibility to ESD.
- b. Component Protection. External protection shall be provided for integrated circuits, discrete components, and other parts not having internal ESD protection that are inherently susceptible to ESD. Protective components shall be installed as close as possible to the ESD susceptible item.
- c. ESD Withstand Requirements. In the installed and operational configuration equipment such as cabinets, enclosures, racks, controls, meters, displays, test points, and interfaces shall withstand a static discharge of 15,000 V in accordance with ANSI/ESDA/JEDEC JS-001, Standard for ESD Sensitivity Testing – Human Body Model (HBM). To successfully pass ESD testing requirements, the tested equipment shall not incur any operational upset, component, or assembly damage.

### 5.6.9 Secure Facilities

In areas of facilities required to maintain communications security, equipment and power systems shall be grounded in accordance with NACSIM-5203 and MIL-HDBK-232A.

### 5.6.10 High RF Field Bonding Requirements

FAA facilities that are located in proximity to other facilities that generate high RF levels need additional shielding to protect personnel and sensitive equipment from these external RF sources. When a determination is made that the signal level is sufficient to cause concern, incorporate the following requirements:

Metal building components and attachments such as walls, roofs, floors, door and window frames, gratings and other metallic architectural features shall be bonded directly to structural steel or to reinforcing bar if structural steel is not present. Where direct bonding is not possible, indirect bonds with copper conductor shall be used. Removable or adjustable parts and objects shall be grounded with an appropriate type bond strap. Metal building components with a maximum dimension of 3 ft or less are exempt from the requirements of this paragraph.

## 5.7 Surge Protective Device (SPD) – Equipment Specification Requirements

### 5.7.1 General

This section provides SPD performance requirements.

### 5.7.2 Surge Protective Device (SPD) for Power Distribution Equipment Protection

The SPD installation shall comply with the following:

- a. Application Listing. The SPD shall be listed in accordance with the latest UL 1449 Standard for SPDs.
- b. Integral Unit Mounted Assemblies. Panelboards and switchgear equipment with integral unit mounted SPD enclosures are permitted if the SPD and panelboard or switchgear integrated components are UL listed and recognized as an assembly.
- c. Enclosure Rating. The SPD components shall be housed in a single steel enclosure, and classified by NEMA as type-12 for indoor use, or type-4 for indoor or outdoor use.
- d. Enclosure Door Hardware. The enclosure door shall be hinged and electrically bonded with a bonding jumper connected to the enclosure. The internal components of the SPD, such as fusing, indicator lights, wiring, and protection elements, shall be accessible for inspection and replacement. The manufacturer's installation and maintenance instructions shall be provided with each SPD unit.
- e. SPD Accessories. Indicator lamps shall be provided for each power phase on the SPD enclosure cover. The lamps shall indicate visually the normal condition when power is applied to the SPD with the component fusing intact. Lamps shall be provided at a minimum service life of 50,000 hours, otherwise two lamps per phase shall be provided.
- f. Potting Material. The SPD enclosure shall be sealed at the power entry points with potting material in accordance with paragraph 4.6.2.3. The use of potting material within SPD components is prohibited, such that all SPD components are accessible at

all times for visual inspection, evaluation, maintenance, or replacement by qualified FAA personnel.

- g. Conductor Terminations. Provide heavy-duty screw terminal studs or lugs for input and output conductor connections. The SPD phase and neutral terminals, when not connected, shall be electrically isolated from the enclosure by a minimum of 10 M $\Omega$  resistance measured at 100 Vdc.

#### 5.7.2.1 SPD - Operational Requirements

The SPD equipment performance shall conform to Table 11, Table 12, and Table 13, and the following parameters:

- a. Maximum Continuous Operating Voltage. The MCOV is the maximum rms voltage an SPD can withstand while operating continuously at maximum temperature without degradation or change to any of its parameters greater than +/-10 percent. The MCOV shall be at least 10 percent above the nominal system voltage. Leakage current, as defined below, shall not be exceeded.
- b. Leakage Current. The dc leakage current shall be less than 1 mA for voltages at or below the dc voltage value of 1.414 x MCOV.
- c. Clamping Discharge Voltage. The CDV is the maximum voltage that appears across an SPD output terminal while conducting surge currents. To ensure performance in the linear region without impacting the device's lifetime performance, the CDV values measured at 3 kA for an 8/20  $\mu$ s current impulse waveform shall not change more than 10 percent over the operating life of the SPD as defined in Table 11.
- d. Overshoot Voltage. Overshoot voltage is the surge voltage level that appears across the SPD terminals before the device turns on and clamps the surge to the specified voltage level. Overshoot voltage shall not exceed two times the SPD clamping voltage for more than 10 ns.
- e. Self-restoring Capability. The SPD shall automatically return to its off state after surge dissipation when line voltage returns to normal.
- f. Operating Lifetime. The SPD shall safely dissipate the number and amplitude of surges listed in Table 11.
- g. In-line Inductors. In-line inductance is not permitted, except from the inductance normally created by the power connection conductors.
- h. Overcurrent Protection. Fuses or circuit breakers that are part of an SPD installation shall be able to pass the surge currents specified in Table 11 without opening.
- i. Short Circuit Current Rating. The SPD short circuit current rating shall be greater than the power distribution system available short circuit current where the equipment is applied in the power distribution system.

##### 5.7.2.1.1 SPD Equipment Performance Data - Surge Current Levels

Table 11 defines the line-to-ground, line-to-neutral, neutral-to-ground, and line-to-line surge current values, and number of surge occurrences for ac power distribution SPD equipment operating below 600 V. In this table, the 8/20  $\mu$ s waveform defines a transient reaching peak

value in 8  $\mu$ s and decaying to 50 percent of peak value 20  $\mu$ s after inception. These devices shall be able to tolerate surges of shorter duration without malfunction.

The following performance change measurements define SPD device failure modes. For the listed parameters, the clamping voltages for each device and assembly are measured at 1 kA and 10 kA for an 8/20  $\mu$ s current impulse waveform.

- a. Change in Clamping Voltage. Any change greater than 10 percent in the 8/20  $\mu$ s clamping voltage at 3 kA during service or when the pre-life service test and post-life or in-service test results are compared is a device failure. The pre-life test value shall be taken as the 100 percent value.
- b. Change in rms Voltage. Any change greater than 10 percent in the rms voltage required to drive 1 mA of rms current through the device when the pre-life service test and post-life or in-service test results are compared is a device failure. The pre-life test value will be taken as the 100 percent value.
- c. Change in dc Voltage. Any change greater than 10 percent in the dc voltage required to drive 1 mA dc through the device when the pre-life service test and the post-life or in-service test results are compared is a device failure. The pre-life test value will be taken as the 100 percent value.

**Table 11. Power Distribution Equipment SPD – Surge Current Lifetime Rating**

Surge Current Level Amplitude with an 8/20 $\mu$ s Waveform, See Note 1 ( kA )	Number of Surges Lifetime for Any Facility Entrance SPD	Number of Surges Lifetime for Feeder and Branch Panelboard SPDs
10	1500	1000
20	700	500
30	375	250
40	50	25
50	8	1
60	6	N/A
70	4	N/A
100	2	N/A
200	1	N/A

**Table Note:**  
 1. Each level of surge current and the number of lifetime surges required represents a single lifetime of the SPD.

**5.7.2.1.2 SPD - Slope Resistance**

The purpose of this parameter is to establish a system that ensures SPD device coordination for equipment protection. The slope resistance  $R_{slope}$ , as calculated by the formula below shall comply with Table 12:

$$R_{slope} = (V_{10} - V_1)/9000$$

Where  $V_{10}$  is the clamping voltage measured at 10 kA for an 8/20  $\mu$ s waveform and  $V_1$  is the clamping voltage measured at 1 kA for an 8/20  $\mu$ s waveform.

The values of  $V_{10}$  and  $V_1$  shall be based on actual measured values of SPD performance testing and not calculated values.

**Table 12. Power Distribution Equipment SPD - Slope Resistance ( $R_{slope}$ )**

Location	Slope Resistance Value
Any Facility Entrance	8 m $\Omega$ Maximum
Feeder and Branch Panelboards	30 m $\Omega$ +/- 15 m $\Omega$

**5.7.2.1.3 SPD - Voltage Protection Rating  $V_3$**

SPD voltage protection rating shall be based on actual measured values of SPD performance testing and not calculated values. Voltages to be achieved during testing at 3 kA for an 8/20  $\mu$ s current impulse waveform are shown in Table 13. All voltages shall be measured at the device terminals. The 8/20  $\mu$ s waveform shall not lead or lag the voltage waveform by more than 30 degrees.

**Table 13. Power Distribution SPD Voltage ( $V_3$ ) Protection Rating**

Location	System Voltage (V)	SPD Voltage Protection Rating ( $V_3$ per mode)	Limit
Facility Entrances	120/208	400 L-N, L-G	Maximum
	120/240	700 L-L	
	277/480	700 L-L, L-G	Maximum
	380 Delta	1200 L-L, L-G	Maximum
Feeder and Branch Panelboards	480 Delta	1200 L-L, L-G	Maximum
	120/208	475 L-N, L-G	+/- 45 V
	120/240	775 L-L	
	277/480	775 L-N, L-G 1275 L-L	+/- 45 V
	380 Delta	1275 L-L, L-G	+/- 45 V
480 Delta	1275 L-L, L-G	+/- 45 V	

### **5.7.3 SPDs for NAS Electronic Equipment – Design and Procurement Requirements**

Provide surge protection for NAS electronic equipment in accordance with paragraph 5.6.3.

### **5.7.4 SPD - Design Specification for Axial Cable Protection**

The design analysis for axial-type cable transient protection shall address the critical RFs and cable insertion losses. Axial cable protection shall comply with the following:

- a. Testing. Performance testing shall be conducted to ensure that suppression components do not degrade signals or cause disruption to the electronic equipment.
- b. RF Signal Testing Criteria. The analyses shall address cable impedance, insertion loss, phase distortion, and system voltage standing wave ratio.
- c. Transient Protection for Electronic Equipment. SPD protection for coaxial, tri-axial, and twin-axial cables shall be provided at the facility entrance point and at the electronic equipment. The transient suppression shall be provided for each axial conductor and for shields that are not bonded directly to the electronic equipment chassis.



## **5.8 Electrostatic Discharge (ESD) Protection – Interface and Specification Requirements**

### **5.8.1 General**

This section provides performance and interface requirements for installation of ESD protective systems. ESD controlled areas shall be provided for operations, storage, repair, and maintenance spaces used for electrical and electronic equipment or subassemblies that are subject to damage from static electricity or ESD. NAS electrical and electronic equipment, subassemblies, and components subject to damage from exposure to electrostatic fields or ESD shall be protected as indicated herein. Approval of any exception to the guidance herein shall be by the OPR.

The requirements of this section are designed to reduce frequency and minimize effects of ESD events. Electronic circuitry that contains miniaturized or solid-state components shall be considered ESD susceptible.

### **5.8.2 Electrostatic Discharge (ESD) Sensitivity Classification**

Classification of items as ESD sensitive shall be in accordance with the HBM testing procedures and requirements of ANSI/ESDA/JEDEC JS-001. Electronic parts, components, and assemblies shall be classified as either sensitive or supersensitive. Items that fail from ESD at 1,000 to 16,000 V shall be classified as ESD sensitive. Items that fail below 1,000 V shall be classified as supersensitive. Devices with a sensitivity of less than +/- 200 V require additional ESD protection measures beyond those specified in this standard. ESD susceptible items shall not be exposed to an electrostatic field greater than 100 V/m, nor located within 24 in. from known static generators or nonessential insulated materials.

### **5.8.3 Classification of Materials**

Most materials and products that are used to control and prevent ESD are classified by their resistive properties as conductive or static dissipative. Antistatic materials are classified by their ability to avoid generating static electricity from triboelectric charging.

Materials used for construction of ESD protected areas (with the exception of antistatic materials) shall meet the resistive properties specified for type and use of the material.

#### **5.8.3.1 Static Conductive Materials**

Those materials with a surface resistivity less than  $1.0 \times 10^5$  ohms per square when tested per ANSI/ESD STM11.11 shall be considered conductive. Conductive ESD control materials shall not be used for ESD control work surfaces, tabletop mats, floor mats, flooring, or carpeting where the risk of personnel contact with energized electrical or electronic equipment exists. Conductive ESD control materials shall not be used in any other application where their use could result in EMI or radio frequency interference (RFI) that would be created by rapid, high-voltage ESD spark discharges.

#### **5.8.3.2 Electrostatic Shielding Materials**

Electrostatic shielding materials are a subset of conductive materials with a surface resistance equal to or less than  $1.0 \times 10^3$  ohms when tested per ANSI/ESD STM11.11. Electrostatic shielding materials are permitted as barriers for protection of ESD sensitive items from electrostatic fields.

### **5.8.3.3 Electromagnetic Shielding Materials**

Electromagnetic shielding materials with highly conductive surfaces less than 10 ohms, or composite materials that absorb and reflect electromagnetic radiation over a broad range of frequencies, are permitted for protection of ESD sensitive items from electromagnetic fields.

### **5.8.3.4 Static Dissipative Materials**

Materials with a surface resistivity greater than  $1.0 \times 10^5$  ohms per square but less than or equal to  $1.0 \times 10^{12}$  ohms per square when tested per ANSI/ESD STM11.11 are classified as static dissipative materials. Static dissipative materials with a surface resistance less than or equal to  $1.0 \times 10^9$  ohms shall provide controlled bleed-off of accumulated static charges in ESD controlled areas. Static dissipative materials with a surface resistance of greater than  $1.0 \times 10^9$  ohms are not permitted for applications where controlled bleed-off of accumulated static charges is required.

### **5.8.3.5 Antistatic Materials**

Materials that inhibit or have a low propensity to generate static electricity from triboelectric charging shall be considered antistatic. Antistatic ESD control items and materials used for construction of ESD controlled areas shall not tribocharge to greater than  $\pm 200$  V when being used for their intended application. Antistatic materials with a surface resistance greater than  $1 \times 10^9$  ohms shall not be used for ESD protective work at surfaces, tabletop mats, floor mats, flooring, and carpeting when charge dissipation is the primary consideration. If the surface resistance ( $R_{tt}$ ) of an antistatic material is greater than  $10^{12}$  ohms, it shall be considered too resistive for use in ESD controlled areas. Use of antistatic items and materials that use hygroscopic surfactants that depend on ambient humidity to promote absorption of water is discouraged. Only antistatic materials that are intrinsically antistatic and retain their antistatic properties shall be used in ESD controlled areas.

### **5.8.3.6 Static-Generative Materials, Nonconductors, and Insulators**

Materials having a surface resistance greater than  $1.0 \times 10^{12}$  ohms (ANSI/ESD STM11.11) shall be considered to be insulators and a potential source of triboelectric charging. These materials include common plastics, Plexiglas, Styrofoam, Teflon, nylon, rubber, untreated polyethylene, and polyurethane. Use of these materials shall be minimized where ESD sensitive items are located.

## **5.8.4 Hard and Soft Grounds**

### **5.8.4.1 Hard Grounds**

Any item, material, or product that is a part of the ESD control system that is intentionally or unintentionally connected to an ESD ground, or connected directly to any SRS in the area served, but not to an SPG system, shall be considered to be hard grounded. Unless specified otherwise or approved by the OPR, all items that comprise the ESD control system shall be hard grounded, such as worksurfaces, cabinets, flooring, carpeting, and test equipment.

#### 5.8.4.2 Soft Grounds

A soft ground is an intentional connection to ground through a series current limiting resistor. Soft grounding shall only be used for personnel grounding skin contact devices, such as wrist straps, leg or ankle straps, conductive shoes, and heel or toe grounders. The nominal resistance of the resistor used for soft grounding of personnel shall be greater than  $1.0 \times 10^6$  ohms unless otherwise approved by the OPR. All other elements of the ESD control system shall be hard grounded.

### 5.8.5 Protection of Electrostatic Discharge (ESD) Susceptible and Sensitive Items

#### 5.8.5.1 Static Protected Zone

A static protected zone shall be a volume or area where there is no direct contact between unprotected ESD sensitive items and electrostatic potentials greater than +/-200 V, electrostatic fields greater than 100 V/m, or radiated EMI and RFI produced by rapid high-voltage ESD spark discharges. Static protected zones shall be incorporated into the construction of ESD special protection areas, ESD protected storage areas, and ESD protected workstations.

#### 5.8.5.2 ESD Special Protection Areas

Special protection areas shall be designated areas that require the following ESD control measures:

- a. Minimize triboelectric charging.
- b. Control bleed-off and dissipation of accumulated static charges.
- c. Neutralize charges.
- d. Minimize the effects of e-fields, h-fields, and EMI/RFI from ESD spark discharges.

Areas within a facility that shall be designated as ESD special protection areas are:

- a. Air Traffic Operations Areas. These include tower cab, TRACON, ARTCC control rooms, and automated flight service station (AFSS) areas.
- b. Electronic Equipment Rooms.
- c. Storage Areas. Areas to store ESD-susceptible components such as subassemblies and circuit cards.
- d. Computer/LAN Interface Areas. Areas that contain personal computers and LANs that are connected to or interface directly with NAS electronic equipment.
- e. Other Locations. Locations where jacks, plug-in connectors, or interfaces of ESD sensitive electronic equipment are exposed and vulnerable to ESD damage by direct human contact.

### 5.8.6 ESD Controls Required for ESD Special Protection Areas

The following ESD control measures shall be implemented in areas designated as ESD special protection areas.

**5.8.6.1 ESD Groundable Point (GP)**

Each ESD control material, surface, or item used in an ESD controlled area shall have a designated GP to provide ease of connection to the nearest SRS.

**5.8.6.2 Grounded Static Dissipative Surfaces**

Work surfaces which include work surface laminates, paints and sealers, writing surfaces, tabletops, consoles, ESD protected workbenches, and tabletop mats shall be static dissipative and connected to an SRS in the area served, but not to an SPG system. The point-to-point resistance and surface-to-ground resistance of static dissipative work surfaces shall be greater than  $1.0 \times 10^6$  ohms and less than  $1.0 \times 10^9$  ohms (ANSI/ESD S4.1).

**5.8.6.3 Limiting the Use of Non-ESD Control Materials**

Materials that will tribocharge, i.e., generate electrostatic potentials by contact and separation with themselves or other materials, shall not be used for construction in ESD special protection areas. Insulative materials and any other non-essential triboelectric charge generators that generate potentials in excess of +/-200 V are not permitted within 24 in. of ESD special protection areas.

**5.8.6.4 Static Dissipative Chairs**

Chairs provided for ESD special protection areas shall incorporate a continuous path between chair elements, such as the cushion and arm rests, to the ground points in the range of greater than  $1.0 \times 10^5$  ohms to less than  $1.0 \times 10^9$  ohms. The ground points for ESD chairs shall be static dissipative or conductive casters that provide electrical continuity from all elements of the chair to ESD control carpeting, tile, or floor mats. These ground points shall be properly bonded to any SRS in the area, but not to an SPG system. ESD control chairs shall be tested and meet the requirements of ANSI/ESD STM12.1.

**5.8.6.5 Static Dissipative ESD Control Floor Coverings**

Static dissipative ESD control floor coverings shall include static dissipative tile, carpeting, static limiting floor finishes, and floor mats. Floor coverings in ESD special protection areas shall have a point-to-point resistance and surface-to-ground resistance of greater than  $1.0 \times 10^6$  ohms and less than  $1.0 \times 10^9$  ohms (ANSI/ESD STM 7.1). These floor coverings shall be bonded to any SRS in the area served in accordance with paragraphs 5.8.6.1 and 5.8.9, but not an SPG system.

In circumstances involving extremely static sensitive equipment, a static conductive floor covering with a lower resistance limit of  $2.5 \times 10^4$  ohms (UL 779) shall be provided when it is part of a system designed for ESD control for the equipment. The system design shall meet all requirements of this standard to produce an electrically safe working environment, and be approved by the OPR.

**5.8.6.6 Relative Humidity Control**

Relative humidity in ESD special protection areas shall be maintained within the range of 40 to 60 percent.

**5.8.7 ESD Signs, Labels, Cautions, and Warnings for ESD Protection Areas**

ESD warning signs shall be posted in ESD special protection areas and other ESD controlled areas. Sign labels shall be marked with an ESD sensitive electronic device warning symbol and other warning and caution labeling information appropriate for personnel safety. ESD warning signs shall be colored yellow with black marking labels and lettering. ESD signs for exterior cabinets housing ESD sensitive electronic equipment shall be visible from at least 3 ft. The sign and labeling style and format shall be consistent, and comply with ANSI/ESD S8.1.

**5.8.8 Electrostatic Discharge (ESD) Protective Storage Areas****5.8.8.1 Shelves, Bins, and Drawers**

Shelves, bins, and drawers shall be static dissipative and electrically continuous with the support structure for the storage shelves, bins, or containers.

**5.8.8.2 Grounding**

The storage container metal support structure shall have a GP connected to the nearest SRS in the area, but not to an SPG system. The resistance from the ground point of storage containers, shelving, cabinets, and bins used to store ESD sensitive items to the nearest SRS shall be less than 1 ohm.

**5.8.8.3 Personnel Grounding**

Wrist straps shall be equipped with 1 megohm or greater series resistance to protect personnel. Standard 0.157-in. banana jacks for personnel grounding wrist straps shall be connected to the ESD ground or directly to any SRS in the area served, but not to an SPG system. The resistance between the banana jack and the GP, and the GP to the nearest SRS, but not to an SRS system, shall be less than 1 ohm.

**5.8.8.4 Materials Prohibited in ESD Protective Storage Areas**

Static generative insulators materials are prohibited for construction in areas where ESD sensitive items will be stored. Materials that can generate potentials greater than +/-200 V shall be located a minimum of 24 in. from ESD protected storage areas.

**5.8.8.5 Resistance to ESD Ground for Shelves, Drawers, and Bins**

Surfaces and drawers of storage media shall be composed of static dissipative materials and shall conform to the resistance testing requirements for worksurfaces (ESD S4.1). The surface-to-surface resistance ( $R_{ts}$ ) and surface-to-ground resistance ( $R_{tg}$ ) from the shelves, bins, and drawers of storage containers used to store unprotected ESD sensitive items shall be greater than  $1.0 \times 10^6$  ohms and less than  $1.0 \times 10^9$  ohms (ESD ADV53.1).

**5.8.8.6 Identification of ESD Protective Storage Areas**

Boundaries of ESD protective storage areas shall be clearly identified. Boundaries of ESD protective storage areas shall extend a minimum of 24 in. beyond the area where ESD sensitive items are located and marked with yellow tape. Highly visible ESD warning signs that are colored yellow with black markings and lettering shall be posted at entrances to these areas. Signs shall include an ESD sensitive electronic device warning symbol and other warning and caution labeling information for personnel safety.

### **5.8.9 Electrostatic Discharge (ESD) Control Flooring and Floor Coverings**

ESD control floors and floor coverings shall have a point-to-point resistance and a surface-to-ground resistance of greater than  $1.0 \times 10^6$  ohms and less than  $1.0 \times 10^9$  ohms (ANSI/ESD STM7.1). ESD control flooring, floor coverings, and floor tile laminates include materials such as vinyl tile, vinyl sheet, carpet, carpet tile, and carpet tile with positioning buttons, but not the applied coatings on the material.

ESD control floors and floor coverings shall be installed, grounded, and initially tested by trained installers in accordance with the manufacturer's recommendations. A representative 10-ft-square section of the flooring system shall be tested and approved by the FAA personnel prior to installation of the full flooring system.

ESD control floors and floor coverings shall be bonded to the nearest SRS in the area served, but not to an SPG system, at a minimum of four locations. The installation methods and testing shall be in accordance with the manufacturer's installation recommendations.

#### **5.8.9.1 Surface Resistance ( $R_{tt}$ )**

Surface resistance  $R_{tt}$  of ESD control floors, carpets, or floor mats shall be greater than  $1.0 \times 10^6$  ohms and less than  $1.0 \times 10^9$  ohms (ANSI/ESD STM7.1). The system surface resistance shall be validated by testing. A minimum of five readings shall be taken at different locations on the floor surface and averaged together for each 500 ft<sup>2</sup>, or fraction thereof, equivalent floor surface. These readings shall be recorded and documented in the Facility Reference Data File (FRDF).

#### **5.8.9.2 Resistance Surface-to-Ground ( $R_{tg}$ )**

Resistance from the floor surface-to-ground  $R_{tg}$  of ESD control floors, carpets or floor mats shall be greater than  $1.0 \times 10^6$  ohms and less than  $1.0 \times 10^9$  ohms (ANSI/ESD STM7.1). The system shall be validated by testing. A minimum of five readings shall be taken at different locations on the floor surface and averaged together for each 500 ft<sup>2</sup>, or fraction thereof, equivalent floor surface. These readings shall be recorded and documented in the FRDF.

#### **5.8.9.3 Triboelectric Charging Limitation**

ESD control floors, carpets, or floor mats shall limit and control generation and accumulation of static charges to less than +/-200 V in ESD controlled areas.

### **5.8.10 Electrostatic Discharge (ESD) Requirements for Raised Access Floor Systems**

#### **5.8.10.1 Resistance between Carpet Surface to Pedestal and Support Substructure**

The resistance between carpet tile surface and the raised access floor pedestal and panel support substructure shall be greater than  $1.0 \times 10^6$  ohms and less than  $1.0 \times 10^9$  ohms.

#### **5.8.10.2 Contact Resistance between Panel to Access Floor Support Substructure**

The contact resistance between the access floor panel system metal parts and the floor substructure shall be less than 10 ohms.

**5.8.10.3 Carpet Tile Installation on Raised Access Floor Panels**

Install individual carpet tiles on raised floor panels with either permanent or releasable conductive adhesive depending on the application.

**5.8.10.4 Grounding of Raised Access Floor System**

A minimum of four connections shall be provided per 1,000 ft<sup>2</sup> of installed ESD control carpeting from the carpeting undersurface and conductive adhesive to the raised access floor panel support substructure. The connections and installation method shall be in accordance with the manufacturer's recommendations, and the testing requirements of paragraphs 5.8.10.1 and 5.8.10.2.

**5.8.11 Electrostatic Discharge (ESD) Protective Worksurfaces**

All worksurfaces, including consoles and ESD-protected workstations and writing surfaces in all areas designated as ESD special protection areas and static-safe zones shall be static dissipative materials or electrostatic dissipative laminates.

**5.8.11.1 Requirements for ESD Protective Worksurfaces**

Static dissipative worksurfaces shall be provided for new or upgrade facilities unless otherwise specified. Permanent static dissipative worksurfaces shall be connected to any SRS in the area served, but not to an SPG system. Permanent ESD protective static dissipative worksurfaces shall have a resistance greater than  $1.0 \times 10^6$  ohms point-to-point ( $R_{tt}$ ) and less than  $1.0 \times 10^9$  ohms (ESD S4.1). Permanent ESD protective worksurfaces shall have a resistance from their surface to the groundable point ( $R_{tg}$ ) greater than  $1.0 \times 10^6$  ohms and less than  $1.0 \times 10^9$  ohms (ESD S4.1).

**5.8.11.2 Worksurface Types**

ESD protective worksurfaces used for ESD protected workstations shall meet the requirements of MIL-PRF-87893 *Performance Specification, Workstation, ESD Control*, and MIL-W-87893 *Military Specification, Workstation, ESD Control*.

**5.8.11.2.1 Type I Worksurface - Hard**

Type I worksurfaces shall be constructed of rigid static dissipative materials of any color having an average Shore D hardness in excess of 90. Two male or female 0.395-in. ground snap (female) or stud (male) fasteners shall be installed on both corners on one of the longest sides of the worksurface to accommodate the male or female snap or stud fastener of the common point grounding cord. The locations of the two snaps or studs shall be 2 in. from each corner.

**5.8.11.2.2 [A5] Type II Worksurface - Soft**

Type II worksurfaces shall be constructed of cushioned static dissipative materials of any color having an average Shore A (ATSM D2240) hardness between 45 and 85. Two male or female 0.395-in. ground snap (female) or stud (male) fasteners shall be installed on both corners on one of the longest sides of the worksurface to accommodate the male or female snap or stud fastener of the common point grounding cord. The locations of the two male or female snaps or studs shall be 2 in. from each corner. Low-density open-cell materials are not permitted for Type II worksurfaces.

### **5.8.11.3 Static Dissipative Laminates**

High-pressure, multilayer static dissipative laminates shall be used to cover surfaces such as plywood, fiber board, particle board, benchtops, countertops, and consoles in ESD controlled areas and special protection areas. Laminates shall include a buried conductive layer to provide for ease of grounding using a through-bolt pressure-type ESD grounding terminal.

### **5.8.11.4 Grounding of Laminated Surfaces**

The resistance across the surface ( $R_{tt}$ ) of the static dissipative laminate shall be greater than  $1.0 \times 10^6$  ohms and less than  $1.0 \times 10^9$  ohms. The resistance from the surface of the laminate to ground ( $R_{tg}$ ) shall be greater than  $1.0 \times 10^6$  ohms and less than  $1.0 \times 10^9$  ohms (ESD S4.1). The system shall be validated through testing. A minimum of five readings of each shall be taken and averaged together. These readings and averages shall be recorded in the FRDF.

### **5.8.12 Static Dissipative Coatings**

Permanent clear or colored static dissipative coatings used in ESD controlled areas, including painted surfaces, shall have a point-to-point resistance greater than  $1.0 \times 10^6$  ohms and less than  $1.0 \times 10^9$  ohms.

### **5.8.13 Electrostatic Discharge (ESD) Protected Workstations**

ESD protected workstations are workbenches used for the maintenance and repair of ESD sensitive equipment.

#### **5.8.13.1 ESD Protected Workstation Minimum Requirements**

ESD control items at an ESD protected workstation shall be connected to a common ESD system GP and bonded to any SRS in the area served, but not to an SPG system. ESD protected workstations shall be free from all nonessential static charge generators, and provide a means of personnel grounding. Workstations shall have a grounded static dissipative work surface, and grounded static dissipative ESD control floor or mat. Storage containers located at ESD protected workstations shall be provided with ESD protection and connected to the ESD system GP. Power outlets for ESD protected workstations shall be protected with a ground fault circuit interruption (GFCI) device to minimize the risk of electrical shock to grounded personnel.

#### **5.8.13.2 Use of Ionization**

Selective use of benchtop or area ionizers is permitted at ESD-protected workstations if static generative insulator items are deemed essential and cannot be removed from the ESD protected workstation area, or the grounding of mobile personnel is not possible or creates a safety hazard.

#### **5.8.13.3 Identification of ESD Protected Workstations**

Boundaries of ESD protected workstations shall be clearly identified with highly visible ESD warning signs. Boundaries of ESD protected workstations shall be identified with yellow tape marking labels. The ESD boundary shall extend a minimum of 24 in. beyond the area where ESD sensitive items are located.

ESD warning signs shall be posted in ESD special protection areas and other ESD controlled areas. Sign labels shall be marked with an ESD sensitive electronic device warning symbol and



other warning and caution labeling information appropriate for personnel safety. ESD warning signs shall be colored yellow with black marking labels and lettering.

## **5.9 Electromagnetic Compatibility Requirements**

### **5.9.1 General**

A comprehensive plan for the application of this standard is required to ensure the compatible operation of equipment in complex systems. Considerations in this section shall be implemented to reduce susceptibility to emissions of electronic equipment.

### **5.9.2 [A6] Requirements**

The emission and susceptibility limits contained in MIL-STD-461 shall be applied unless otherwise specified. An electromagnetic interference (EMI) Control and Test Plan shall be developed in accordance with MIL-HDBK-237 to ensure compliance with the applicable requirements. The plan shall include a verification matrix to track the satisfaction of requirements by test, analysis, or inspection.

### **5.9.3 Approval**

Control and Test Plans shall be submitted to the OPR for approval.

This Page Intentionally Left Blank

## 6 NOTES

### 6.1 Acronyms and Abbreviations

The following are acronyms and abbreviations used in this standard.

<b>A</b>		
	A	Ampere
	ac	alternating current
	AFSS	automated flight service station (FAA Acronym)
	ANSI	American National Standards Institute
	ARTCC	Air Route Traffic Control Center
	ASSC	airport surface surveillance capability system
	ATCT	Airport Traffic Control Tower
	AWG	American Wire Gauge
<b>C</b>		
	CDV	clamping discharge voltage
	cmil	circular mils
	COTS	commercial off-the-shelf
<b>D</b>		
	dB	Decibel
	dc	direct current
	DEB	direct earth burial
	diam	Diameter
<b>E</b>		
	e.g.	for example
	EES	earth electrode system
	EGC	equipment grounding conductor
	EMI	electromagnetic interference
	EMT	electrical metallic tubing
	ESD	electrostatic discharge
	et al.	and others
	etc	et cetera
<b>F</b>		
	FAA	Federal Aviation Administration
	FRDF	facility reference data file (FAA Acronym)
	ft	foot (feet)
<b>G</b>		
	GEC	grounding electrode conductors
	GFCI	ground fault circuit interruption
	GP	groundable point
<b>H</b>		
	Hz	hertz
	HBM	human body model

FAA-STD-019f

<b>I</b>		
	i.e.	that is
	IFR	Instrument Flight Rules (FAA Acronym)
	IMC	intermediate metal conduit
	in.	inch
	IEEE	Institute of Electrical and Electronics Engineers
<b>K</b>		
	kA	kiloampere
	kcmil	thousand circular mils
	kHz	kilohertz
<b>L</b>		
	LAN	local area network
	lb	pound
	LPGBS	Lightning Protection, Grounding, Bonding and Shielding
	L-G	Line-to-Ground
	L-L	Line-to-Line
	L-N	Line-to-Neutral
	LLWAS	low level wind shear alert system (FAA Acronym)
<b>M</b>		
	m	meter
	mm	millimeter
	mA	milliampere
	mΩ	milliohm
	MΩ	megohm
	MCOV	Maximum continuous operating voltage
	MHz	megahertz
	MPG	multipoint ground system
	MPGP	multipoint ground plate
	μs	microsecond
<b>N</b>		
	NAS	National Airspace System
	NAVAIDS	navigation aids
	NEC	National Electrical Code
	NEMA	National Electrical Manufacturers Association
	NFPA	National Fire Protection Association
	ns	nanosecond
<b>O</b>		
	OCPD	overcurrent protective device
	OM	outer marker (FAA Acronym)
	OPR	Office of Primary Responsibility
	Ω	ohm
<b>P</b>		
	PIV	peak inverse voltage
	PVC	polyvinyl chloride

FAA-STD-019f

<b>R</b>		
	RF	radio frequency
	RGS	rigid galvanized steel
	RFI	radio-frequency interference
	RMC	rigid metal conduit
	rms	root-mean-square
	$R_{slope}$	slope resistance
	$R_{tg}$	surface-to-ground resistance
	$R_{tt}$	surface resistance
	RVR	runway visual range (FAA Acronym)
<b>S</b>		
	SDM	service disconnecting means
	SPD	surge protective device
	SPG	single point ground system
	SPGP	single point ground plate
	SRGG	signal reference ground grid
	SRGP	signal reference ground plane
	SRM	safety risk management
	SRS	signal reference structure
	SSC	system support center (FAA Acronym)
<b>T</b>		
	TELCO	telephone company (FAA Acronym)
	ton	unit of mass or weight
	TRACON	terminal radar approach control facility
	TVSS	transient voltage surge suppressors
<b>U</b>		
	UL	Underwriters Laboratories
	UPS	uninterruptible power supply
<b>V</b>		
	V	volt
	$V_{dc}$	volts direct current
	VOR	very high frequency (VHF) omni directional range (FAA Acronym)
<b>W</b>		
	$\lambda$	Frequency Wavelength

## 6.2 Guidelines and Reference Notes

### [A1] Paragraph 4.2.1.1

See FAA-HDBK-010 for evaluation, inspection, and testing procedures.

### [A2] Paragraph 4.2.3.4.1

See MIL-STD-889, paragraphs “Precautions and methods for joining” and “Recommended Treatments in Order of Protective Effectiveness” for additional guidance for completing bond joints where base metals for couples are not permitted in Table 1.

### [A3] Paragraph 4.4.2

The site survey geotechnical investigation data and EES design configuration are expected to be documented and retained within the facility’s as-built documentation set, in accordance with FAA Order 630.45, Facility Reference Data File.

### [A4] Paragraph 4.4.4.4

Access wells located in nontraffic areas should be medium duty rated per AASHTO H-20 design load criterion up to 40,000 lb. Access wells subject to vehicular traffic should be traffic rated per AASHTO M306 proof loading criterion up to 100,000 lb. Access wells subject to aircraft loading should be Airport rated per AASHTO M306 proof loading criterion up to 200,000 lb.

### [A5] Paragraph 5.8.11.2.2

Guidance for measurement of material hardness properties is in ATSM-D2240, Standard Test Method for Rubber Property - Durometer Hardness, ASTM International, West Conshohocken, PA, 2015, [www.astm.org](http://www.astm.org).

### [A6] Paragraph 5.9.2

Guidance for EMI protection is in MIL-HDBK-253, and for ESD in NFPA 77, DODHDBK-263, DOD-STD-1686, and IEEE 1100.

## 6.3 Version Cross-Reference

Due to the major reorganization of FAA-STD-019F it is not feasible to provide an exact cross-reference between this standard and the previous versions of FAA-STD-019. The OPR should be consulted for assistance in determining references to the original requirements in previous editions of FAA-STD-019.

## 6.4 Bibliography

[B1] NFPA 70, National Electrical Code, National Fire Protection Association, Current Edition.

[B2] NFPA 75, Standard for the Fire Protection of Information Technology Equipment, National Fire Protection Association, Current Edition.

[B3] NFPA 780, Standard for the Installation of Lightning Protection Systems Handbook, National Fire Protection Association, Current Edition.

[B4] IEEE 1100, IEEE Recommended Practice for Powering and Grounding Electronic Equipment, Institute of Electrical and Electronics Engineers, Inc., Current Edition.

[B5] IEEE C2, National Electrical Safety Code, Institute of Electrical and Electronics Engineers, Inc., Current Edition.

[B6] MIL-HDBK-419, Department of Defense, Military Handbook: Grounding, Bonding, and Shielding for Electronic Equipments and Facilities, Volume I, Current Edition.

[B7] MIL-HDBK-419, Department of Defense, Military Handbook: Grounding, Bonding, and Shielding for Electronic Equipments and Facilities, Volume II, Current Edition.

[B8] MIL-HDBK-237, Department of Defense, Military Handbook: Electromagnetic Environmental Effects and Spectrum Supportability Guidance for the Acquisition Process, Current Edition.

[B9] MIL-STD-188-124, Department of Defense, Military Standard: Grounding, Bonding and Shielding for Common Long Haul/Tactical Communication Systems Including Ground Based Communications Electronics Facilities and Equipments, Current Edition.

[B10] MIL-STD-461, Department of Defense, Interface Standard: Requirements for the Control of Electromagnetic Interference Characteristics of Subsystems and Equipment, Current Edition.

[B11] MIL-STD-464, Department of Defense, Interface Standard: Electromagnetic Environmental Effects Requirements for Systems, Current Edition.

[B12] MIL-STD-889, Department of Defense, Military Standard: Dissimilar Metals, Current Edition.

[B13] MIL-STD-962, Department of Defense, Standard Practice: Format and Content, Current Edition.

This Page Intentionally Left Blank